

# Handles

TESA

ASSA ABLOY



# All the possibilities to dress doors in an exclusive way



A handle can completely change the look of a building. Choosing the right handle can influence countless parameters: functionality, aesthetics, durability... This is why [TESA](#) presents a wide range of handles for the institutional

market (stainless, aluminium) and for residential applications, fire resistant doors and aluminium profiles. A range in which you will find the model that best fits with each project.

## A wide range of handles

TESA has created a very wide range of handles. In the residential range we still find TESA's classic handles such as Barcelona, Delta, Hermes, etc. But there's also a Brass range (SOLID) with various designs and finishes, specifically designed to adapt to the needs and demands of a great variety of users. TESA has also made progress on the institutional range, with two new ranges in stainless steel: AISI 304 and AISI 316L, with a wide range of handles. TESA has also created an artistic institutional design range, so far called MARE.



## Quality institutional range

TESA has two ranges in stainless steel: 304 and 316L. The first one is aimed basically at offices and institutional buildings with standard applications. And the handles with an stainless steel AISI 316L finish are basically aimed at high traffic institutional and commercial buildings subject to extreme conditions. They are suitable for many different solutions: RF doors, panic exit devices, fire doors, etc.



## Design handles: high range: MARE

TESA also believes strongly in artistic handles with a modern design, while at the same time creating an institutional product. Nowadays TESA is manufacturing the MARE handle, designed by Ricardo Bofill and Marta Vilallonga, which is a combination of beauty and functionality.



## Residential: quality guarantee for the "solid" range

With a view to maintain its leadership, TESA has given a five-year warranty to the SOLID residential range. Because we trust our product and processes, we can offer the market a standard warranty and corrosion resistance.



## Guaranteed by TESA

To buy TESA is a quality guarantee. The use of state-of-the-art technology, experienced staff and a managing system certificated by the quality standard ISO 90001 and the environment standard ISO 14001, as well as the security and hazard prevention standard, have resulted in a career of continued innovation, growth and expansion for the company.



Get ready for TESA's complete range of handles. A range in which you will find everything from our traditional models to the avant-garde models exclusively designed by Marta Vilallonga and Ricardo Bofill's workshop. They all bring you an extraordinary combination of elements and features that give a precise an-

swer to each door. Answers and solutions that no one else can offer, as here you will find handles capable of resisting -50° temperatures, chemical aggressions or extreme use conditions, whose performance remains unaffected through the years.



Handles	Institutional			Residential		Fire doors	Aluminium carpentry	Rosette	Long Plate	Squared plate
	AISI304	AISI316L	Aluminium	Classic	Solid					
Sena	•	•	•			•	•	☞	▬▬▬	▭▭▭
Vector	•	•	•				•	☞	▬▬▬	▭▭▭
Xara		•					•	☞	▬▬▬	▭▭▭
Zafira		•					•	☞	▬▬▬	▭▭▭
Sector		•					•	☞	▬▬▬	▭▭▭
Mare							•	☞	▬▬▬	
Cubo	•	•					•	☞	▬▬▬	▭▭▭
Ladho	•						•	☞		
Radho	•						•	☞		
Planho		•					•	☞	▬▬▬	▭▭▭
Obbal		•					•	☞	▬▬▬	▭▭▭
Kubika		•					•	☞	▬▬▬	▭▭▭
Sena-I		•								
Tundra		•								
Thema				•				☞	▬▬▬	
Delta				•				☞	▬▬▬	
Hermes				•				☞	▬▬▬	
Kira				•				☞	▬▬▬	
Arco				•				☞	▬▬▬	
Monobloc						•			▬▬▬	
M2000							•			
M1500							•			
Solid					•					

# Index

<b>RESIDENTIAL HANDLES</b>	<b>6</b>	<b>Complements</b>	<b>22</b>	<b>Institutional stainless AISI 304 handle</b>	<b>42</b>
<b>Premium range</b>	<b>6</b>	Key hole for Kubika / Tundra	22	<b>Complements</b>	<b>42</b>
Rosette handles	6	Key hole for Obbal / Sena-I	22	Thumb turns Ø53	42
Voila and Elsa	7	Thumb turn for Kubika / Tundra	22	Door frame deadbolt	42
Complements for Yanca, Cadi, Tundra, Elsa, Hamat & Voila	7	Thumb turn for Obbal / Sena-I	22	Flush ring Socket pull	42
Novoa and Eben	7			Cylinder pull - Europrofile	42
Complements for Novoa and Eben	7			Flush pull handle - Oval	42
<b>Residential handles</b>	<b>8</b>	<b>Gama 316L</b>	<b>24</b>	<b>Accessories - Institutional stainless AISI 304</b>	<b>43</b>
<b>Complements D50</b>	<b>9</b>	Rosette	24	<b>Bolts and socket</b>	<b>43</b>
Euro profile	9	Long plate	24	<b>Stopper</b>	<b>44</b>
Thumbturn	9	Aquare plate	24	Doorstop for floor	44
Warded key	9	Vector	24	Coath hook w/ rubber buffer	44
Blank plate	9	Cubo	24	<b>Accessories</b>	<b>45</b>
<b>Solid</b>	<b>10</b>	Xara	24	PULL-PUSH puller	45
Praga	10	Tundra	24	Solid Type Stainless pull handles	46
Dublin	10	Fixed knob	24	Stainless pull handles Ø20 mm	46
Bucarest	10	Half knob on long plate	24	Stainless pull handles Ø30 mm	47
Madrid	11	Zafira	24	Stainless pull handles Ø30 mm	48
Estocolmo	11	Planho	24	<b>Handles for fire rated doors</b>	<b>49</b>
Oslo	12	Sena AISI 316L	25	Sena Series	49
Yalta	12	Vector AISI 316L	26	Monobloc Series	50
<b>Accessories Solid</b>	<b>13</b>	Xara AISI 316L	27	<b>Handles for Metallic carpentry (steel and aluminium)</b>	<b>52</b>
Long-Plated Pull Handle set	13	Zafira AISI 316L	28	Aluminium series	52
Rosette Pull Handle set	13	Sector AISI 316L	29	<b>Solutions for special applications</b>	<b>53</b>
Pull knob	13	Cubo AISI 316L	30	Antimicrobial door handle	53
Wardrobe Plate	13	Planho AISI 316L	31	Photoluminiscent handle	53
Car Boot Plate	13	<b>Institutional leverset for emergency exits</b>	<b>32</b>	<b>Solutions for special applications</b>	<b>54</b>
Rosette	13	<b>Certified product EN179:2008</b>	<b>32</b>	<b>Stand-alone access control</b>	<b>54</b>
Thumb turn with unblocking	13	Sena Inox AISI 316L	32	<b>Electronic digital handle for windows</b>	<b>56</b>
<b>PREMIUM INSTITUTIONAL HANDLE</b>	<b>14</b>	Sena pull handle with squared plate	33	For swinging and sliding doors	57
<b>Mare</b>	<b>14</b>	Key holes	34	<b>Accessories</b>	<b>58</b>
<b>complements</b>	<b>16</b>	Blank	34	Floating through bolts for doors up to 70 mm (plate and rosette)	58
Squared key holes	16	Thumb turns	34	Bolts	58
Rounded key holes	16	Sena AISI 304	36	Recoil springs	58
Squared thumb turns	16	Vector AISI 304	37	Braille signposting	58
Rounded thumb turns	16	Cubo stainless AISI 304	38	Reducers	59
<b>INSTITUTIONAL HANDLE</b>	<b>17</b>	Ladho stainless AISI 304	38	Spindles	59
<b>Institutional stainless AISI 316L handle</b>	<b>17</b>	Radho stainless AISI 304	38		
Kubika and Obbal handles	17	9 mm spindle SS304 handle	38		
Kubika AISI 316L	18	<b>Institutional stainless AISI 304 handle complements</b>	<b>39</b>		
Obbal AISI 316L	19	Key holes Ø50	39		
Sena-I AISI 316L	20	Blank	39		
Tundra st. steel AISI 316L	21	Thumb turns Ø50	39		
		<b>Solid Lever handles Stainless AISI 304</b>	<b>40</b>		
		Nova Stainless AISI 304	40		
		Oasis Stainless AISI 304	40		
		Wind Stainless AISI 304	40		
		Mach Stainless AISI 304	40		
		<b>Solid Lever handles Stainless AISI 304</b>	<b>41</b>		
		Arena Stainless AISI 304	41		
		Funxtion Stainless AISI 304	41		
		Marina Stainless AISI 304	41		
		Yas Stainless AISI 304	41		

# Residential handles

## Premium range

We have made the finest selection of handles for interior designs. A renewed strength and simplicity in the design of doors that makes them immediately recognizable. A good design requires an excellent knowledge of the raw materials and its application to the last detail. The selected raw materials are:

- » The Stainless Steel AISI 304 is an austenitic steel (18% chromium, 8% nickel) that offers an excellent corrosion resistance, even in the harsh environment of exterior installations. Is practically unalterable with the suitable treatment.

It far exceeds the maximum grade of the corrosion resistance standard UNE-EN 1670. It has excellent resistance to chemical attacks and in addition is unalterable to ultraviolet.

- » Zamak-5 (UNE 37302 1 a R and DIN 1743-1) is a zinc alloy (4% aluminum, 1% copper, 0.05% magnesium, 94.95% zinc). Applying the right processes to this zinc alloy it turns into the unique material capable of creating complex designs.

It is a hard, highly durable & injectable material, very well suited for applications with high friction levels.

## Rosette handles

### The package with a rosette includes



» A set of handles with a back and cover plate, a 8x100 mm spindle, 2 recoil springs, 4 coach screws, 2 through bolts, 2 bolts and an Allen key.



Model	Product code	Finish
Yanca	MYA5R800	CM
Cadi	MCA5R800	CM
Elsa	MEL5R800	CM
Hamat	MHA5R800	IS

Model	Product code	Finish
Tundra	MTU5R800	CM
Voila	MVO5R800	CM

### Dimensions:

-  52 mm
-  Ø52 mm

# Residential handles

## Premium range

### Voila and Elsa

#### The package with a long plate includes

- » A set of handles with long plate, a 8 x 100 mm spindle, 2 recoil springs and a through bolt

#### Functions

- » Entrance: keyhole 85, 72, 70 and 47 mm.
- » Thumb turn: dead bolt 85, 72, 70 and 47 mm.
- » Passage.
- » Plate dimensions: 210x52x10

Voila

Elsa



Model	Product code	Finish
Voila	MVO5L800	CM
Elsa	MEL5L800	CM

### Novoa and Eben

#### The package with a rosette includes

- » A set of handles with an internal plate and a cover, a 8x100 mm spindle, 2 recoil springs, 4 coach screws, 2 through bolts (only Eben) and 1 Allen key.

Novoa: Ø 45

Eben: Ø 52

Novoa

Eben



Model	Product code	Finish
Novoa	MNO5R800	CM
Eben	MEB5R800	CM

### Complements for Yanca, Cadi, Tundra, Elsa, Hamat & Voila



Product code	Finish
MPBORBOM (square)	CM - IS
MPBOREME (square)	CM - IS
MPBOREMER (round)	CM - IS
MPBORBOMR (round)	CM - IS

### Complements for Novoa and Eben



Product code	Finish
MNOREME	CM
MNOBORBOM	CM
MEBREME	CM
MEBBORBOM	CM

# Residential handles

Specifically designed for residential buildings. Choice is based mainly on aesthetic and design criteria.

Zamak-5 (UNE 37302 1a R and DIN 1743-1) is a zinc alloy (4% aluminium, 1% copper, 0.05% magnesium, 94.95% zinc). It is a hard, highly resistant injectable material, very adequate for applications demanding high friction levels. Brass is a copper and

zinc alloy whose main advantages are malleability, ductility and mechanical resistance to atmospheric corrosion.

Handles with a brass base piece are also subject to various treatments before resulting in the finished product: The brass handle has been polished, achieving a satin or matt finish.

## The pack with a rosette includes

- » A set of handles with an internal plate and a cover, a 8x105 mm spindle, a recoil spring, 4 coach screws, 2 bolts and an allen key.

## The pack with a long plate includes

- » A set of handles with a long plate, a 8x105 mm spindle, a recoil spring, 4 coach screws, 2 bolts, an allen key and instructions for hand change in privacy function.

## Functions

- » Front-end: keyhole at 85, 72, 70 and 47 mm; for half handle, keyhole at 85, 72, 70 and 47 mm.
- » Privacy: deadbolt at 85, 72, 70 and 47 mm.
- » Passage.

Finishes: LP/LM/CR/CM/MB/NE/NS  
(check for special colours)

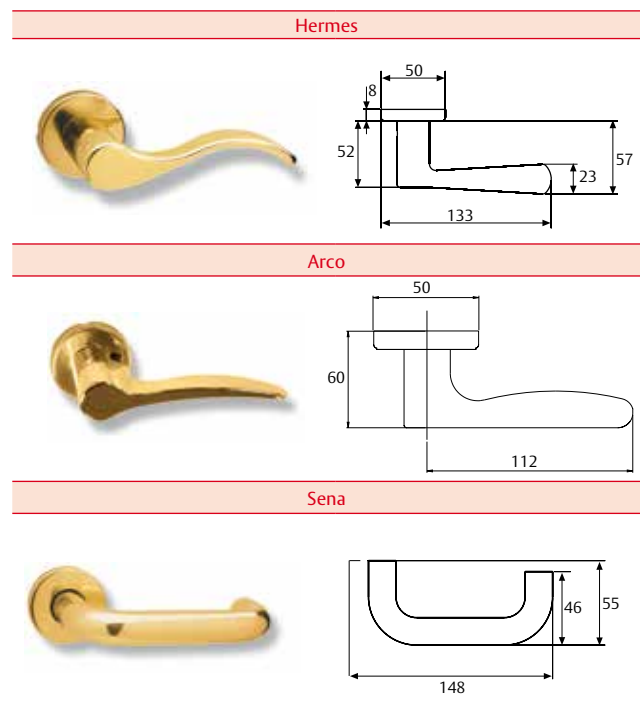
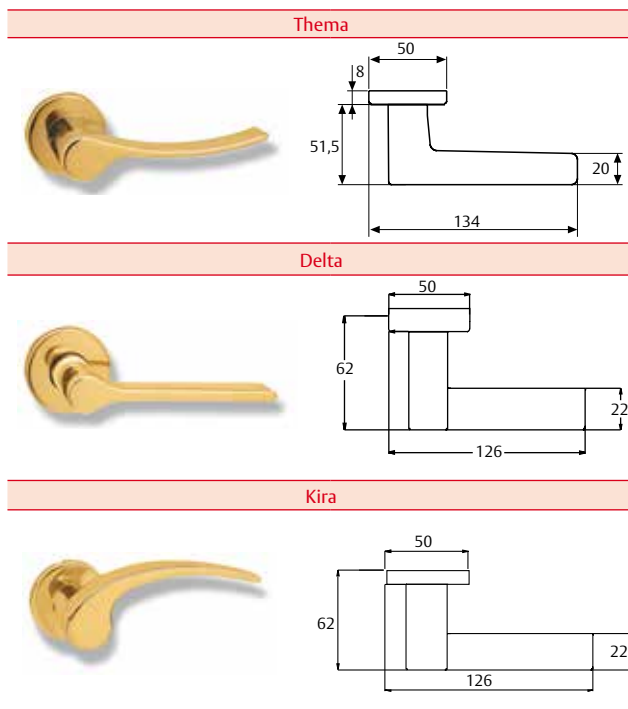

## Product code construction

Handle	Function	Escutcheons	Spindle	Distance between axis	Finishes
Barcelona (MB)	Passage (5)	Rosette (R)	8	47 / 70 / 72 / 85	Polished brass (LP)
Arco (MA)	Entrance (0)	Long plate (L)			Satin brass (LM)
Delta (MD)	Privacy (E)				Satin chrome (CM)
Sena (MS)					Bright chrome (CR)
Kira (MK)					PVD (LPD) *
Vector (MV)					
Hermes (MH)					

\*Metallic aspect with high resistance



# Residential handles

## Complements D50

### Euro profile

- The pack includes
- » A set with support pieces and covers.
  - » 4 coach screws.



- Finishes
- » LP / LM / CR / CM / MB / NE / NS / LA / LPD / BL.

Product code	Finishes
MBORBOM	MB
MBORBOM	NE
MBORBOM	BL
MBORBOM	LPD

Product code	Finishes
MBORBOM	LP
MBORBOM	LM
MBORBOM	CR
MBORBOM	CM

### Warded key

- The pack includes
- » A set with support pieces and covers.
  - » 4 coach screws.

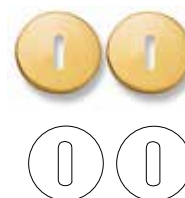

- Finishes
- » LP / LM / CR / CM / MB / NE / NS / LA / LPD / BL.

Product code	Finishes
MBORBOR	LP
MBORBOR	LM
MBORBOR	CR
MBORBOR	CM

Product code	Finishes
MBORBOR	MB
MBORBOR	NE
MBORBOR	BL
MBORBOR	LPD

### Thumbturn

- The pack includes
- » A set with support pieces and covers.
  - » A 6 x 52 mm spindle.
  - » 4 coach screws.

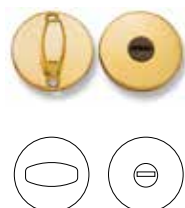

- Finishes
- » LP / LM / CR / CM / MB / NE / NS / LA / LPD / BL.

Product code	Finishes
MBOREME	LP
MBOREME	LM
MBOREME	CR
MBOREME	CM

Product code	Finishes
MBOREME	MB
MBOREME	NE
MBOREME	BL
MBOREME	LPD

### Blank plate

- The pack includes
- » A set with support pieces and covers.
  - » 4 coach screws.

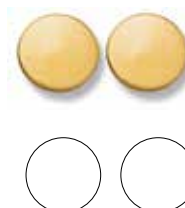

- Finishes
- » LP / LM / CR / CM / MB / NE / NS / LA / LPD / BL.

Product code	Finishes
MBOR000	LP
MBOR000	LM
MBOR000	CR
MBOR000	CM

Product code	Finishes
MBOR000	MB
MBOR000	NE
MBOR000	BL
MBOR000	LPD



# Residential handles

## Solid

The residential segment also features a collection of top handles: the Solid range. A highly resistant, versatile and wide brass range with seven different long-plated and rosette models and various finishes. Due

to the high demand of this stock, maximum operativity is guaranteed. The best proof of the reliability of this product is the whole ranges' exclusive five-year warranty of operation and corrosion resistance.

### Praga

#### Features

- » A set of long-plated handles.
- » Finishes: LP and LPLM.
- » Functions: keyhole at 85, 70 and 47 mm.
- » Privacy: deadbolt at 70 and 47 mm.

Description	Product code	Finishes
Long plate	MPR5L800	LPLM - LP
Key hole 47 mm	MPROL847	LPLM - LP
Key hole 70 mm	MPROL870	LP LM - LP
Key hole 85 mm	MPROL885	LPLM - LP
Deadbolt	MPREL847	LPLM - LP

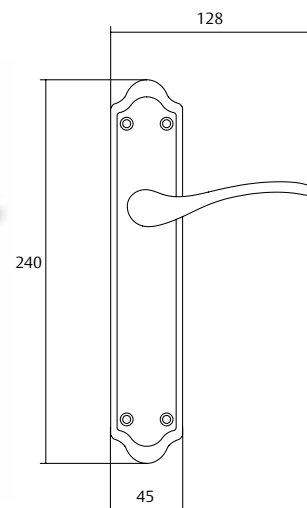

### Dublin

#### Features

- » A set of rosette handles.
- » Finish: LP y NS

Description	Product code	Finishes
Rosette	MDU5R800	LP - NS

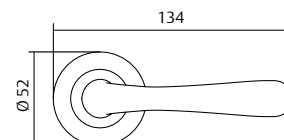

### Bucarest

#### Features

- » A set of rosette handles.
- » Finish: NS

Description	Product code	Finishes
Rosette	MBU5R800	NS

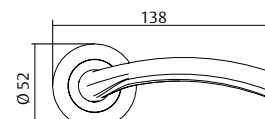

# Residential handles

## Solid

### Madrid

- » A set of long-plated handles.
- » Finishes: LP
- » Functions: keyhole at 85, 70 and 47 mm.
- » Privacy: deadbolt at 70 and 47 mm.

Description	Product code	Finish
Long plate	MMA5L800	LP
Key hole 47 mm	MMA0L847	LP
Key hole 70 mm	MMA0L870	LP
Key hole 85 mm	MMA0L885	LP
Deadbolt	MMAEL847	LP

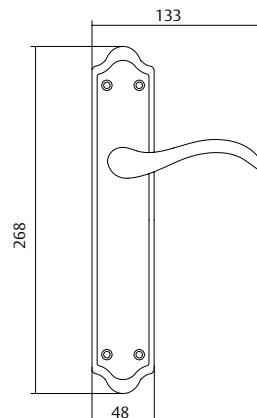

### Estocolmo

#### Features:

- » A set of long-plated and rosette handles .
- » Finishes: LP and NS.
- » Functions: keyhole at 85, 70 and 47 mm.
- » Privacy: deadbolt at 70 and 47 mm.

Description	Product code	Finishes
Long plate	MES5L800	LP - NS
Key hole 47 mm	MES0L847	LP - NS
Key hole 70 mm	MES0L870	LP - NS
Key hole 85 mm	MES0L885	LP - NS
Deadbolt	MESEL847	LP - NS
Rosette	MES5R800	LP - NS

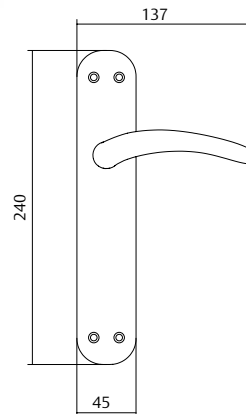
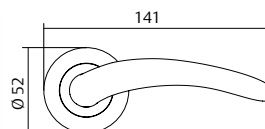

# Residential handle

## Solid

### Oslo

#### Features

- » A set of long-plated (LP) and rosette handles.
- » Finishes: LP and NS (only rosette).

Description	Product code	Finishes
Long plate	MOS5L800	LP
Key hole 47 mm	MOS0L847	LP
Key hole 70 mm	MOS0L870	LP
Key hole 85 mm	MOS0L885	LP
Deadbolt	MOSEL847	LP
Rosette	MOS5R800	LP - NS

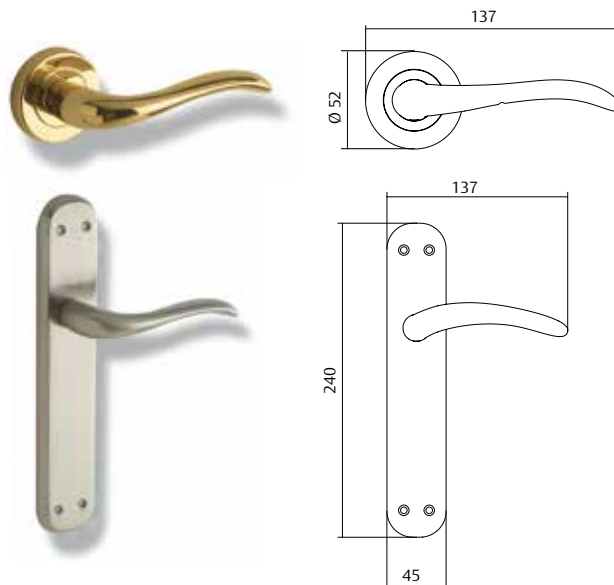

### Yalta

#### Features

- » A set of long-plated and rosette handles.
- » Finishes: LP
- » Functions: keyhole at 85, 70 and 47 mm.
- » Privacy: deadbolt at 70 and 47 mm.
- » Rosette 50mm diameter

Description	Product code	Finishes
Long plate	MY5L800	LP
Key hole 47 mm	MY0L847	LP
Key hole 70 mm	MY0L870	LP
Key hole 85 mm	MY0L885	LP
Deadbolt	MYEL847	LP
Rosette	MY5R800	LP

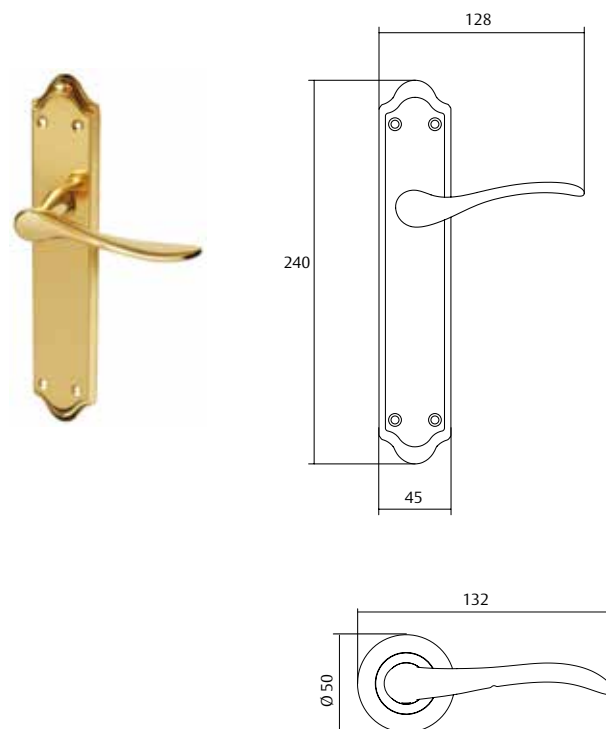

# Accessories

## Solid

### Long-Plated Pull Handle set

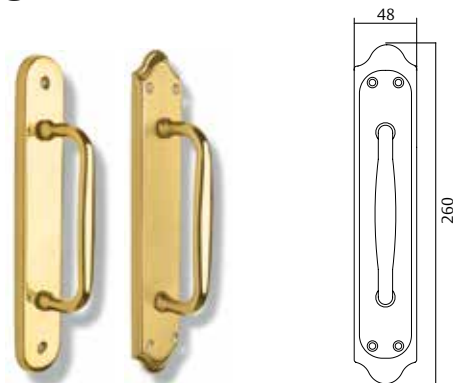

Model	Product code	Finishes
Praga	TICL00 (Praga)	LPLM - LP
Dublin / Bucarest	TIMO00 (Dublin, Bucarest)	LP
Amsterdam	TIIN00 (Amsterdam)	LPLM - LP
Estocolmo / Oslo	TIME00 (Estocolmo, Oslo)	NS - LP
Madrid	TIAL00 (Madrid)	LPLM - LP

### Wardrobe Plate



Description	Product code	Finishes
Praga, Amsterdam, Madrid (passage)	PLA5CL00	LPLM - LP
Dublin, Bucarest, Estocolmo, Oslo (passage)	PLA5MO00	LP

### Car Boot Plate



Description	Product code	Finishes
Praga, Amsterdam, Madrid (passage)	PLM5CL00	LPLM - LP
Dublin, Bucarest, Estocolmo, Oslo (passage)	PLM5MO00	NS

### Rosette Pull Handle set

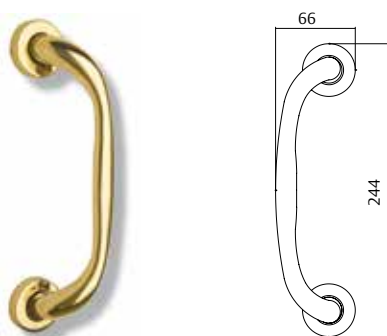

Product code	Finishes
TISOR00	LP

### Rosette



Description	Product code	Finishes
Key hole rosette (2 units)	ROSOBOM	LP - NS
Deadbolt rosette (emergency) (2 units)	ROSOEME	LP - NS

### Pull knob



Description	Product code	Finishes
Pomo	PSO500	LP

### Thumb turn with unblocking



Description	Product code	Finishes
Thumb turn with unblocking	MULSOL	LP
Thumb turn with unblocking	MULSOL	NS



# Premium institutional handle

## Mare

The Mare handle is among the high-range institutional handles, aimed at public buildings, hotels, auditoriums, etc. Extremely resistant, it has been designed by Ricardo Bofill and Marta Vilallonga's renowned studio. It combines beauty, functionality and solidity.

It meets the legislation currently in force for building fittings UNE - EN 1906 and reaches the highest degree in use, durability and corrosion resistance categories.

### Finish ISD, features to highlight:

- » Unaffected by sweating.
- » Unaffected by the attack of solvents.
- » Employed as a protection tool with medical instruments.
- » Highly resistant to corrosion due to the chrome foundation previous to the application of PVD.
- » The external layers are three times stronger than chromium.
- » Resistant to ultraviolet rays. The colour of the finish will not wear off, which is why it's ideal for outdoors.

### Fixing system

- » Bolts: patented MARE fixing system. Hidden screws are used in order to prevent handles from being stolen.

### PVD finish.

- » Highly resistant finish that gives the handle a metallic look. PVD is the equivalent to a chrome or stainless finish with a metallic brass look.
- » From the PVD we obtain the finishes ISD, LPD and LMD.

Minimum corrosion resistance (ASTM-B117/90):

- » CM, CR, PVD and IS16 finishes: up to 500 hours
- » NS, LP and LM: up to 144 hours.



CERTIFIED TO  
**UNE-EN**  
1634-1:2010



# Premium institutional handle

## Mare

### The pack with a round rose includes

» A set of handles, a 8x105 mm expansion spindle, 2 recoil springs, 8 coach screws, 2 M6x9 bolts, an Allen key. It includes instructions.

Finishes: LP, LM, CM, CR, NS, LPD.

### Functions

- » Entrance: keyhole at 85, 72 and 70 mm.
- » Privacy: deadbolt at 85, 72 and 70 mm.
- » Passage.

### The pack with a long plate includes

» A set of handles, a 8x105 mm expansion spindle, 2 recoil springs, 2 internal supporting pieces, 16 coach screws, 2 M6x9 bolts and an Allen key. It includes instructions and an assembly template.

Finishes: LP, LM, CM, CR, NS, LPD, IS16.



Squared rosette	Product code	Finishes	Cylinder at 85 mm	Product code	Finishes
	MM5RC800	LP		MMOL885	LP
	MM5RC800	LM		MMOL885	LM
	MM5RC800	CM		MMOL885	CM
	MM5RC800	CR		MMOL885	CR
	MM5RC800	NS		MMOL885	NS
	MM5RC800	LPD		MMOL885	LPD
	MM5RC800	ISD		MMOL885	ISD
Rosette	Product code	Finishes	Deadbolt at 85 mm	Product code	Finishes
	MM5R800	LP		MMEL885	LP
	MM5R800	LM		MMEL885	LM
	MM5R800	CM		MMEL885	CM
	MM5R800	CR		MMEL885	CR
	MM5R800	NS		MMEL885	NS
	MM5R800	LPD		MMEL885	LPD
	MM5R800	ISD		MMEL885	ISD
Long plate	Product code	Finishes	Pull lever 400 mm	Product code	Finishes
	MM5L800	LP		TICM4020	LP
	MM5L800	LM		TICM4020	LM
	MM5L800	CM		TICM4020	CM
	MM5L800	CR		TICM4020	CR
	MM5L800	NS		TICM4020	NS
	MM5L800	LPD		TICM4020	LPD
	MM5L800	ISD		TICM4020	ISD
Cylinder at 70 mm	Product code	Finishes	Pull lever 250 mm	Product code	Finishes
	MMOL870	LP		TICM2520	LP
	MMOL870	LM		TICM2520	LM
	MMOL870	CM		TICM2520	CM
	MMOL870	CR		TICM2520	CR
	MMOL870	NS		TICM2520	NS
	MMOL870	LPD		TICM2520	LPD
	MMOL870	ISD		TICM2520	ISD
			KITMCRIS	Kit for glass door	

# Premium institutional handle: Complements

## Squared key holes

The pack includes:

- » A set of supporting pieces and covers
- » 8 screws.



Product code	Finishes
MACBORBOM	LP
MACBORBOM	LM
MACBORBOM	CM
MACBORBOM	CR
MACBORBOM	NS
MACBORBOM	LPD
MACBORBOM	ISD

## Squared thumb turns

The pack includes:

- » A set of supporting pieces and covers, 8 coach screws, an axis thumbturn spindle, an emergency spindle, a handle spindle, a 6x52m spindle, a M4x18 torx screw and 2 supporting pieces.



Product code	Finishes
MACBOREME	LP
MACBOREME	LM
MACBOREME	CM
MACBOREME	CR
MACBOREME	NS
MACBOREME	LPD
MACBOREME	ISD

## Rounded key holes

The pack includes:

- » A set of supporting pieces and covers
- » 8 screws.



Product code	Finishes
MABORBOM	LP
MABORBOM	LM
MABORBOM	CM
MABORBOM	CR
MABORBOM	NS
MABORBOM	LPD
MABORBOM	ISD

## Rounded thumb turns

The pack includes:

- » A set of supporting pieces and covers, 8 coach screws, an axis thumbturn spindle, an emergency spindle, a handle spindle, a 6x52m spindle, a M4x18 torx screw and 2 supporting pieces.



Product code	Finishes
MABOREME	LP
MABOREME	LM
MABOREME	CM
MABOREME	CR
MABOREME	NS
MABOREME	LPD
MABOREME	ISD

### Dimensions:

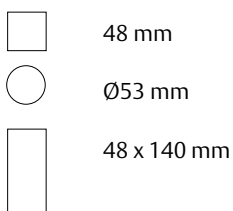



# Institutional stainless AISI 316L handle

## Kubika and Obbal handles

In the development of Kubika and Obbal, TESA has applied a totally innovating methodology regarding design for new products. After an intensive market research, the original aesthetics of these handles has been a consequence of the product codes and trends shown by

the different actors in the high range and quality handles market. Kubika and Obbal fulfill special, singular and unique benefits concerning resistance, security, flexibility and high quality materials. Let's enhance some of them:

### Resistance

- » The driving mechanism of the handle is covered by acetate resin which prevents the break of the spring due to corrosion and also guarantees more than 500.000 cycles of working order.
- » The springs are compression kind (as shock absorbers in the car) so his hollows are grooved; we achieve like this that the system still works even if in the supposed case of spring breakage due to fatigue.
- » Very high resistance to breakage and free movement as a consequence of the system of springs dragging by nut with two cotter pins.
- » Tests: both models have got excellent results in the internal tests. They have put up with the double effort compared with our previous handles and the competitor's ones.

### Flexibility

- » The rose models have 8 different crossing points for the coach screws, which makes them compatible with most of the locks in the market. At the same time Kubika and Obbal can be assembled with TESA antipanic exit devices ranges Universal, Push and Top.
- » Easy to reverse that helps converting simply one right handle into left handle and vice versa.

### High quality materials

- » This handles are manufactured in AISI 316L stainless steel, also known as 'marine steel' due to his excellent behavior in aggressive and saline environments.

### Security

- » The mechanism is fixed to the handle and escutcheon through a screw. We remove like this the clip used by all the handles in the market, the most frequent failure that let us with the handle on the hand. This system is like a 'sandwich', all pieces are joined by a special screw (M14x1) that guarantees that we will never keep the handle in the hand.



G

# Institutional stainless AISI 316L handle

## Kubika AISI 316L

### The pack with a rosette includes

- » A set of handles with an internal plate and a cover, a 8x105 mm spindle, 2 recoil springs, 4 coach screws, 2 through bolts, 2 bolts and an Allen key.

### The pack with a long plate includes

- » A set of handles with an internal plate and a cover, a 8x105 mm spindle, 2 through bolts, 2 recoil springs, 4 coach screws, 2 bolts and an Allen key.

### The pack with a squared plate includes

- » A set of handles with a 1'5 mm-thick internal plate and a cover, a 8x105 mm spindle, 2 recoil springs, 4 through bolts, 4 screws, 2 bolts and an Allen key.

### Functions

- » Entrance: keyhole at 85, 72, 70 and 47 mm.
- » Privacy: deadbolt at 85, 72, 70 and 47 mm.
- » Passage.

Rosette	Product code	Finishes
Squared rosette	MKU5R800	IS16
Metallic carpentry rosette	Product code	Finishes
1/2 handle squared rosette	MKURR800	IS16
Long plate	Product code	Finishes
Passage	MKU5L800	IS16
Cylinder at 72 mm	MKU0L872	IS16
Cylinder at 85 mm	MKU0L885	IS16
Deadbolt at 70 mm	MKUEL870	IS16
Squared plate	Product code	Finishes
Passage	MKU5C800	IS16
Cylinder at 72 mm	MKU0C872	IS16
Cylinder at 85 mm	MKU0C885	IS16
Deadbolt at 85 mm	MKU3C885	IS16

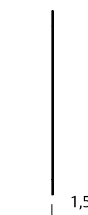
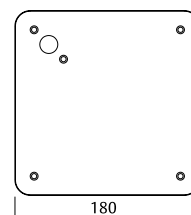
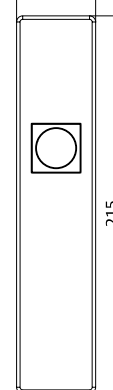
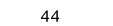
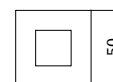
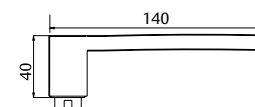
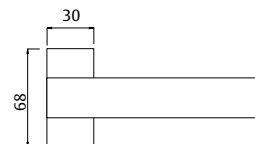

# Institutional stainless AISI 316L handle

## Obbal AISI 316L

### The pack with a rosette includes

- » A set of handles with an internal plate and a cover, a 8x105 mm spindle, 2 recoil springs, 4 coach screws, 2 through bolts, 2 bolts and an Allen key.

### The pack with a long plate includes

- » A set of handles with an internal plate and a cover, a 8x105 mm spindle, 2 recoil springs, 4 coach screws, 2 bolts and an Allen key.

### The pack with a squared plate includes

- » A set of handles with a 1'5 mm-thick internal plate and a cover, a 8x105 mm spindle, 2 recoil springs, 4 through bolts, 4 screws, 2 bolts and an Allen key.

### Functions

- » Entrance: keyhole at 85, 72, 70 and 47 mm.
- » Privacy: deadbolt at 85, 72, 70 and 47 mm.
- » Passage.

Rosette	Product code	Finish
Rounded rosette	MO5R800	IS16
Metallic carpentry rosette	Product code	Finish
1/2 handle rounded rosette	MORR800	IS16
Long plate	Product code	Finish
Passage	MO5L800	IS16
Cylinder at 72 mm	MO0L872	IS16
Cylinder at 85 mm	MO0L885	IS16
Deadbolt at 70 mm	MOEL870	IS16
Squared plate	Product code	Finish
Passage	MO5C800	IS16
Cylinder at 72 mm	MO0C872	IS16
Cylinder at 85 mm	MO0C885	IS16
Deadbolt at 85 mm	MO3C885	IS16

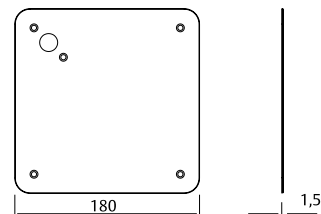
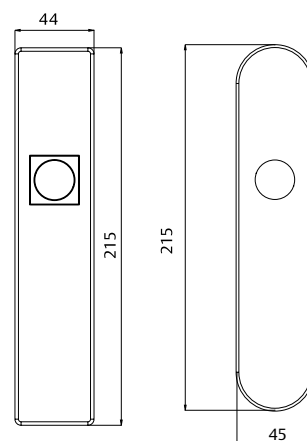
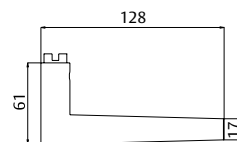

G

# Institutional stainless AISI 316L handle

## Sena-I AISI 316L

### The pack with a rosette includes

- » A set of handles with an internal plate and a cover, 1 8x105 mm spindle, 2 recoil springs, 4 coach screws, 2 bolts and an Allen key.

### The pack with a long plate includes

- » A set of handles with an internal plate and a cover, a 8x105 mm spindle, 2 recoil springs, 4 coach screws, 2 bolts and an Allen key.
- » Rectangular plate also available

### The pack with a squared plate includes

- » A set of handles with a 1'5 mm-thick internal plate and a cover, a 8x105 mm spindle, 2 recoil springs, 5 floating through bolts, 5 screws, 2 bolts and an Allen key.

### Functions

- » Entrance: keyhole at 85, 72, 70 and 47 mm.
- » Privacy: deadbolt at 85, 72, 70 and 47 mm.
- » Passage.

Rosette	Product code	Finishes
Rosette	MSI5R800	IS16
Long plate	Product code	Finishes
Passage	MSI5LR800	IS16
Rectangular	MSI5LR800	IS16
Cylinder at 47 mm	MSI0L847	IS16
Cylinder at 70 mm	MSI0L870	IS16
Cylinder at 72 mm	MSI0L872	IS16
Cylinder at 85 mm	MSI0L885	IS16
Deadbolt at 47 mm	MSI0L847	IS16
Deadbolt at 70 mm	MSI0L870	IS16
Deadbolt at 72 mm	MSI0L872	IS16
Deadbolt at 85 mm	MSI0L885	IS16
Square plate	Product code	Finishes
Pasagege	MSI5C800	IS16
Cylinder at 47 mm	MSI0C847	IS16
Cylinder at 70 mm	MSI0C870	IS16
Cylinder at 72 mm	MSI0C872	IS16
Cylinder at 85 mm	MSI0C885	IS16
Deadbolt at 47 mm	MSI3C847	IS16
Deadbolt at 70 mm	MSI3C870	IS16
Deadbolt at 72 mm	MSI3C872	IS16
Deadbolt at 85 mm	MSI3C885	IS16

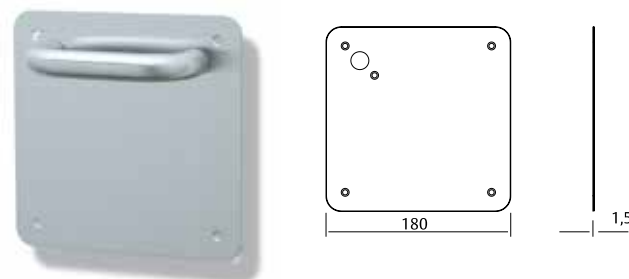
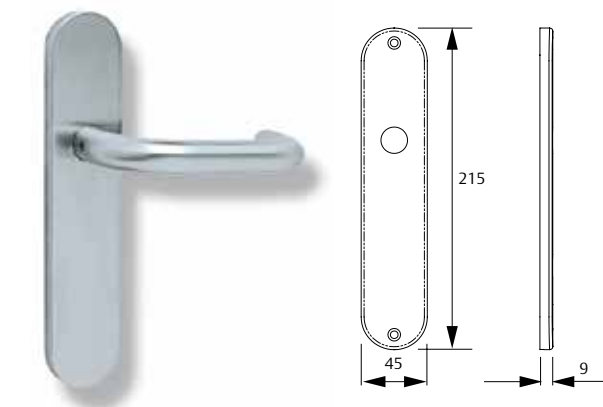
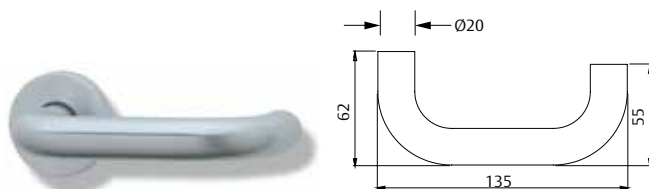

# Institutional stainless AISI 316L handle

## Tundra st. steel AISI 316L

### The pack with a rosette includes

- » A set of handles with an internal plate and a cover, a 8x105 mm spindle, 2 recoil springs, 4 coach screws, 2 through bolts, 2 bolts and an Allen key.

### The pack with a long plate includes

- » A set of handles with an internal plate and a cover, a 8x105 mm spindle, 2 through bolts, 2 recoil springs, 4 coach screws, 2 bolts and an Allen key.

### The pack with a squared plate includes

- » A set of handles with a 1'5 mm-thick internal plate and a cover, a 8x105 mm spindle, 2 recoil springs, 4 through bolts, 4 screws, 2 bolts and an Allen key.

### Functions

- » Entrance: keyhole at 85, 72, 70 and 47 mm.
- » Privacy: deadbolt at 85, 72, 70 and 47 mm.
- » Passage.



Long plate	Product code	Finishes
Passage	MTU5L800	IS16
Rectangular	MTU5LR800	IS16
Cylinder at 47 mm	MTU0L847	IS16
Cylinder at 70 mm	MTU0L870	IS16
Cylinder at 72 mm	MTU0L872	IS16
Cylinder at 85 mm	MTU0L885	IS16
Deadbolt at 47 mm	MTUEL847	IS16
Deadbolt at 70 mm	MTUEL870	IS16
Deadbolt at 72 mm	MTUEL872	IS16
Deadbolt at 85 mm	MTUEL885	IS16
Square plate	Product code	Finishes
Passage	MTU5C800	IS16
Cylinder at 47 mm	MTU0C847	IS16
Cylinder at 70 mm	MTU0C870	IS16
Cylinder at 72 mm	MTU0C872	IS16
Cylinder at 85 mm	MTU0C885	IS16
Deadbolt at 47 mm	MTU3C847	IS16
Deadbolt at 70 mm	MTU3C870	IS16
Deadbolt at 72 mm	MTU3C872	IS16
Deadbolt at 85 mm	MTU3C885	IS16

# Institutional stainless AISI 316L handle complements

## Key hole for Kubika / Tundra

Packaging includes:

- » A set of supporting pieces and covers.
- » 4 screws.



Finishes

- » IS16

Product code	Finish
MKUBORBOM	IS16

## Thumb turn for Kubika / Tundra

Packaging includes:

- » A set of supporting pieces and covers.
- » A 6 x 52 mm spindle
- » 4 screws.



Finishes

- » IS16

Product code	Finish
MKUBOREME	IS16

## Key hole for Obbal / Sena-I

Packaging includes:

- » A set of supporting pieces and covers.
- » 4 screws.



Finishes

- » IS16

Product code	Finish
MBORBOM	IS16

## Thumb turn for Obbal / Sena-I

Packaging includes:

- » A set of supporting pieces and covers.
- » A 6 x 52 mm spindle
- » 4 screws.



Finishes

- » IS16

Product code	Finish
MBOREME	IS16

# Institutional stainless AISI 316L handle

Addressed basically to institutional and commercial buildings with high traffic and subject to extreme conditions. They are applicable to all kind of : RF doors, panic exit devices, fire doors, fixings for fixed through bolts, applications for double follower locks, etc.

## Stainless steel AISI 316L finish

It is an austenitic steel with molybdenum, low carbon content (18% chromium, 11% nickel, 2% molybdenum). Molybdenum protects stainless steel from pitting corrosion, which is common in industrial or seaside environments.

## Features

Recoil spring protected by an acetate resin cartridge for maximum corrosion resistance.  
Fixing with floating or fixed through bolts, for maximum traction

resistance.  
Fixing with TESA expansion spindles, ensuring high traction resistance.  
Hidden screws in order to avoid handles from being theft.

## Regulations

It meets the requisites of the UNE-EN 1906 standard for architectural fittings.

It is also way above the maximum grade of the corrosion resistance standard UNE-EN 1670.

Excellent resistance to chemical attacks.

## Fixing system

Depending on each model, fixing is carried out with fixed through bolts, floating through bolts, or coach screws straight onto the door's leaf.



# 316L range

Rosette



Fixed knob



Long plate



Half knob on long plate



Square plate



Vector



Xara



Zafira

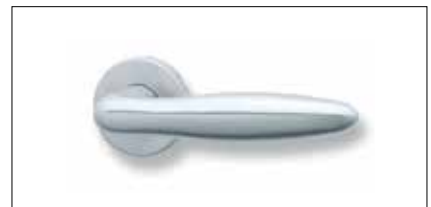

Cubo



Tundra



Planho





# Institutional stainless AISI 316L handle

## Sena AISI 316L

### The pack with a rosette includes

- » A set of handles with an internal plate and a cover, a 8x105 mm spindle, 2 recoil springs, 4 coach screws, 2 bolts and an Allen key.

### The pack with a long plate includes

- » A set of handles with an internal plate and a cover, a 8x105 mm spindle, 2 recoil springs, 4 coach screws, 2 bolts and an Allen key.
- » Rectangular plate also available

### The pack with a squared plate includes

- » A set of handles with a 1'5 mm-thick internal plate and a cover, a 8x105 mm spindle, 2 recoil springs, 5 floating through bolts, 5 screws, 2 bolts and an Allen key.

### Functions

- » Entrance: keyhole at 85, 72, 70 and 47 mm.
- » Privacy: deadbolt at 85, 72, 70 and 47 mm.
- » Passage.

Rosette	Product code	Finishes
Rosette	MS5R800	IS16
Rosette	MMTFR800	IS16 1/2 Fixed knob + CUADRAE
Rosette	MSTFR800	IS16 1/2 Fixed knob + CUADRAE + 1/2 Sena
Rosette	MTF5R800	IS16 Double Fixed knob + 2 CUADRAE
Long plate	Product code	Finishes
Passage	MS5L800	IS16
Rectangular	MS5LR800	IS16
Cylinder at 47 mm	MS0L847	IS16
Cylinder at 70 mm	MS0L870	IS16
Cylinder at 72 mm	MS0L872	IS16
Cylinder at 85 mm	MS0L885	IS16
Deadbolt at 47 mm	MSEL847	IS16
Deadbolt at 70 mm	MSEL870	IS16
Deadbolt at 72 mm	MSEL872	IS16
Deadbolt at 85 mm	MSEL885	IS16
Square plate	Product code	Finishes
Pasagge	MS5C800	IS16
Cylinder at 47 mm	MS0C847	IS16
Cylinder at 70 mm	MS0C870	IS16
Cylinder at 72 mm	MS0C872	IS16
Cylinder at 85 mm	MS0C885	IS16
Deadbolt at 47 mm	MS3C847	IS16
Deadbolt at 70 mm	MS3C870	IS16
Deadbolt at 72 mm	MS3C872	IS16
Deadbolt at 85 mm	MS3C885	IS16

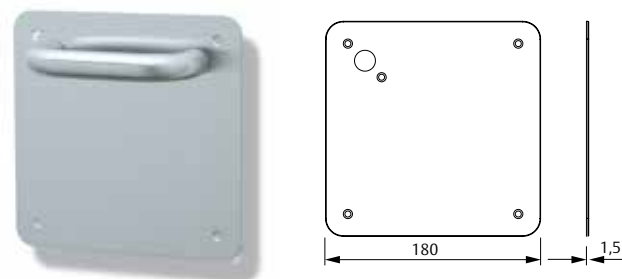
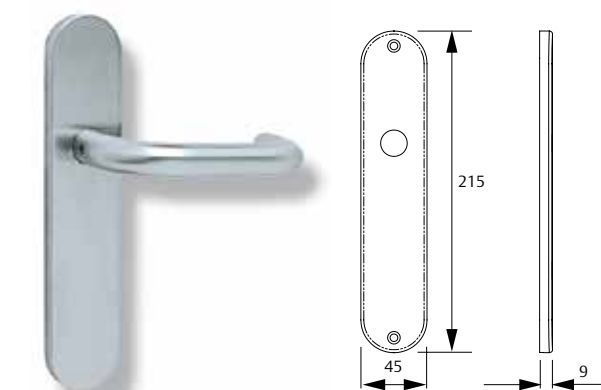
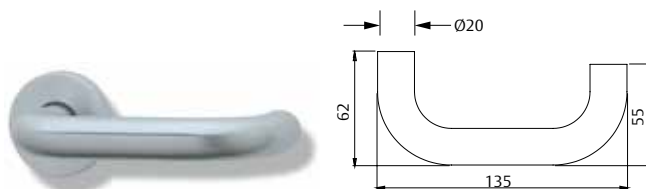

# Institutional stainless AISI 316L handle

## Vector AISI 316L

### The pack with a rosette includes

- » A set of handles with an internal plate and a cover, 1 8x105 mm spindle, 2 recoil springs, 4 coach screws, 2 bolts and an Allen key.

### The pack with a long plate includes

- » A set of handles with an internal plate and a cover, a 8x105 mm spindle, 2 recoil springs, 4 coach screws, 2 bolts and an Allen key.
- » Rectangular plate also available

### The pack with a squared plate includes

- » A set of handles with a 1'5 mm-thick internal plate and a cover, a 8x105 mm spindle, 2 recoil springs, 5 floating through bolts, 5 screws, 2 bolts and an Allen key.

### Functions

- » Entrance: keyhole at 85, 72, 70 and 47 mm.
- » Privacy: deadbolt at 85, 72, 70 and 47 mm.
- » Passage.

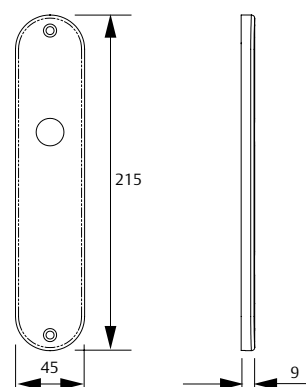
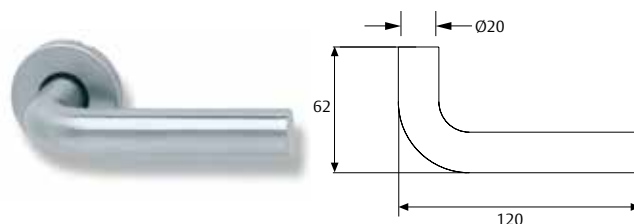

Rosette	Product code	Finish
Rosette	MV5R800	IS16
Rosette	MVTR800	IS16 1/2 Fixed knob + CUADRE + 1/2 vector

Long plate	Product code	Finish
Passage	MV5L800	IS16
Cylinder at 47 mm	MV0L847	IS16
Cylinder at 70 mm	MV0L870	IS16
Cylinder at 72 mm	MV0L872	IS16
Cylinder at 85 mm	MV0L885	IS16
Deadbolt at 47 mm	MVEL847	IS16
Deadbolt at 70 mm	MVEL870	IS16
Deadbolt at 72 mm	MVEL872	IS16
Deadbolt at 85 mm	MVEL885	IS16

Square plate	Product code	Finish
Passage	MV5C800	IS16
Cylinder at 47 mm	MV0C847	IS16
Cylinder at 70 mm	MV0C870	IS16
Cylinder at 72 mm	MV0C872	IS16
Cylinder at 85 mm	MV0C885	IS16
Deadbolt at 47 mm	MV3C847	IS16
Deadbolt at 70 mm	MV3C870	IS16
Deadbolt at 72 mm	MV3C872	IS16
Deadbolt at 85 mm	MV3C885	IS16

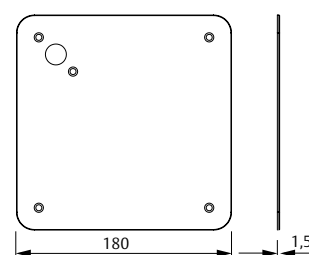

# Institutional stainless AISI 316L handle

## Xara AISI 316L

### The pack with a rosette includes

- » A set of handles with an internal plate and a cover, a 8x105 mm spindle, 2 recoil springs, 4 coach screws, 2 bolts and an Allen key.

### The pack with a long plate includes

- » A set of handles with an internal plate and a cover, a 8x105 mm spindle, 2 recoil springs, 4 coach spindle, 2 bolts and an Allen key.
- » Rectangular plate also available

### The pack with a squared plate includes

- » A set of handles with a 1'5 mm-thick internal plate and a cover, a 8x105 mm square, 2 recoil springs, 5 floating through bolts, 5 screws, 2 bolts and an Allen key.

### Functions

- » Entrance: keyhole at 85, 72, 70 and 47 mm.
- » Privacy: deadbolt at 85, 72, 70 and 47 mm.
- » Passage.

Rosette	Product code	Finish
Rosette	MX5R800	IS
Long plate	Product code	Finish
Passage	MX5L800	IS16
Cylinder at 47 mm	MX0L847	IS16
Cylinder at 70 mm	MX0L870	IS16
Cylinder at 72 mm	MX0L872	IS16
Cylinder at 85 mm	MX0L885	IS16
Deadbolt at 47 mm	MXEL847	IS16
Deadbolt at 70 mm	MXEL870	IS16
Deadbolt at 72 mm	MXEL872	IS16
Deadbolt at 85 mm	MXEL885	IS16
Square plate	Product code	Finish
Passage	MX5C800	IS16
Cylinder at 47 mm	MX0C847	IS16
Cylinder at 70 mm	MX0C870	IS16
Cylinder at 72 mm	MX0C872	IS16
Cylinder at 85 mm	MX0C885	IS16
Deadbolt at 47 mm	MX3C847	IS16
Deadbolt at 70 mm	MX3C870	IS16
Deadbolt at 72 mm	MX3C872	IS16
Deadbolt at 85 mm	MX3C885	IS16

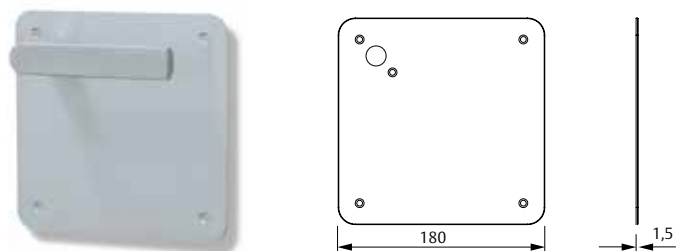
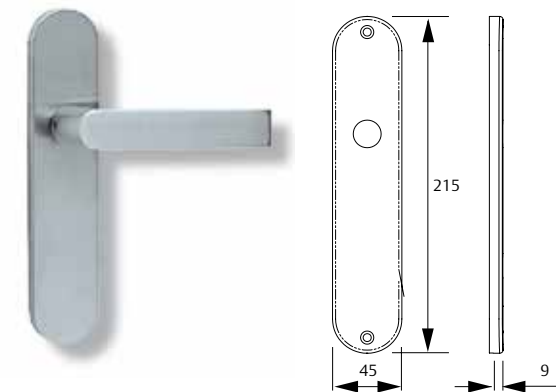
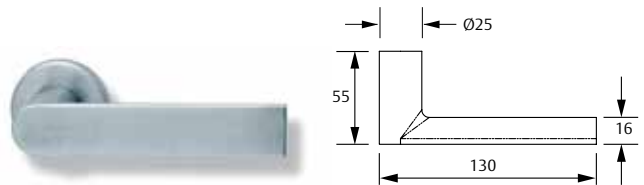

# Institutional stainless AISI 316L handle

## Zafira AISI 316L

### The pack with a rosette includes

- » A set of handles with an internal plate and a cover, a 8x105 mm spindle, 2 recoil springs, 4 coach screws, 2 bolts and an Allen key.

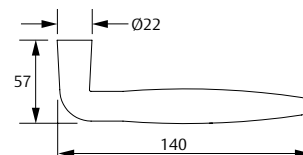

### The pack with a long plate includes

- » A set of handles with an internal plate and a cover, a 8x105 mm spindle, 2 recoil springs, 4 coach screws, 2 bolts and an Allen key.
- » Rectangular plate also available.

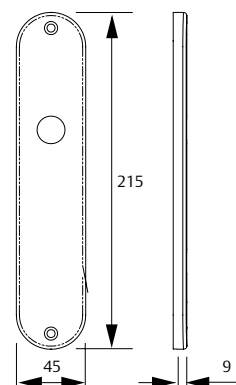

### The pack with a squared plate includes

- » A set of handles with a 1'5 mm-thick internal plate and a cover, a 8x105 mm spindle, 2 recoil springs, 5 floating through bolts, 5 screws, 2 bolts and an Allen key.

### Functions

- » Entrance: keyhole at 85, 72, 70 and 47 mm.
- » Privacy: deadbolt at 85, 72, 70 and 47 mm.
- » Passage.

Rosette	Product code	Finish
Rosette	MZ5R800	IS16
Long plate	Product code	Finish
Passage	MZ5L800	IS16
Cylinder at 47 mm	MZ0L847	IS16
Cylinder at 70 mm	MZ0L870	IS16
Cylinder at 72 mm	MZ0L872	IS16
Cylinder at 85 mm	MZ0L885	IS16
Deadbolt at 47 mm	MZEL847	IS16
Deadbolt at 70 mm	MZEL870	IS16
Deadbolt at 72 mm	MZEL872	IS16
Deadbolt at 85 mm	MZEL885	IS16
Square plate	Product code	Finish
Passage	MZ5C800	IS16
Cylinder at 47 mm	MZ0C847	IS16
Cylinder at 70 mm	MZ0C870	IS16
Cylinder at 72 mm	MZ0C872	IS16
Cylinder at 85 mm	MZ0C885	IS16
Deadbolt at 47 mm	MZ3C847	IS16
Deadbolt at 70 mm	MZ3C870	IS16
Deadbolt at 72 mm	MZ3C872	IS16
Deadbolt at 85 mm	MZ3C885	IS16

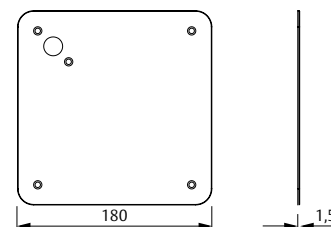

# Institutional stainless AISI 316L handle

## Sector AISI 316L

### The pack with a rosette includes

- » A set of handles with an internal plate and a cover, a 8x105 mm spindle, 2 recoil springs, 4 coach screws, 2 bolts and an Allen key.

### The pack with a long plate includes

- » A set of handles with an internal plate and a cover, a 8x105 mm spindle, 2 recoil springs, 4 coach screws, 2 bolts and an Allen key.
- » Rectangular plate also available.

### The pack with a squared plate includes

- » A set of handles with a 1'5 mm-thick internal plate and a cover, a 8x105 mm spindle, 2 recoil springs, 5 floating through bolts, 5 screws, 2 bolts and an Allen key.

### Functions

- » Entrance: keyhole at 85, 72, 70 and 47 mm.
- » Privacy: deadbolt at 85, 72, 70 and 47 mm.
- » Passage.

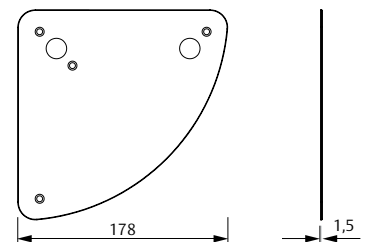
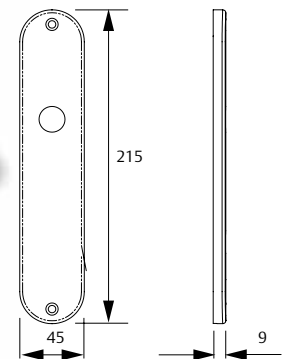
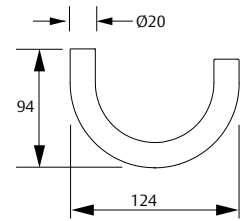

Rosette	Product code	Finish
Rosette	MSE5R800	IS16
Long plate	Product code	Finish
Passage	MSE5L800	IS16
Cylinder at 47 mm	MSE0L847	IS16
Cylinder at 70 mm	MSE0L870	IS16
Cylinder at 72 mm	MSE0L872	IS16
Cylinder at 85 mm	MSE0L885	IS16
Deadbolt at 47 mm	MSEEL847	IS16
Deadbolt at 70 mm	MSEEL870	IS16
Deadbolt at 72 mm	MSEEL872	IS16
Deadbolt at 85 mm	MSEEL885	IS16
Square plate	Product code	Finish
Passage	MSE5S800	IS16
Cylinder at 47 mm	MSE0S847	IS16
Cylinder at 70 mm	MSE0S870	IS16
Cylinder at 72 mm	MSE0S872	IS16
Cylinder at 85 mm	MSE0S885	IS16
Deadbolt at 47 mm	MSE3S847	IS16
Deadbolt at 70 mm	MSE3S870	IS16
Deadbolt at 72 mm	MSE3S872	IS16
Deadbolt at 85 mm	MSE3S885	IS16

# Institutional stainless AISI 316L handle

## Cubo AISI 316L

### The pack with a rosette includes

- » A set of handles with an internal plate and a cover, a 8x105 mm spindle, 2 recoil springs, 4 coach screws, 2 bolts and an Allen key.

### The pack with a long plate includes

- » A set of handles with an internal plate and a cover, a 8x105 mm spindle, 2 recoil springs, 4 coach screws, 2 bolts and an Allen key.
- » Rectangular plate also available.

### The pack with a squared plate includes

- » A set of handles with a 1'5 mm-thick internal plate and a cover, a 8x105 mm spindle, 2 recoil springs, 5 floating through bolts, 5 screws, 2 bolts and an Allen key.

### Functions

- » Entrance: keyhole at 85, 72, 70 and 47 mm.
- » Privacy: deadbolt at 85, 72, 70 and 47 mm.
- » Passage.

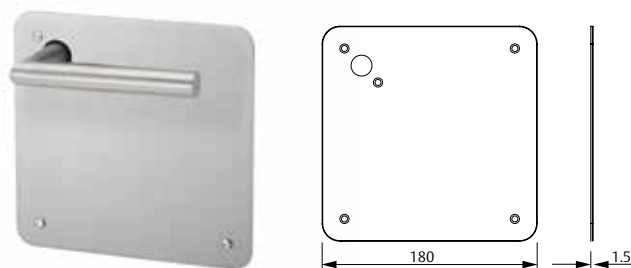
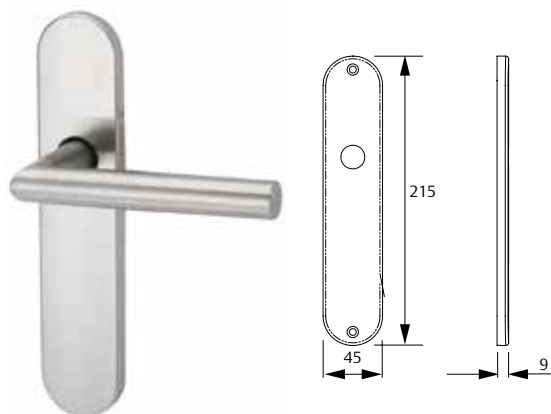
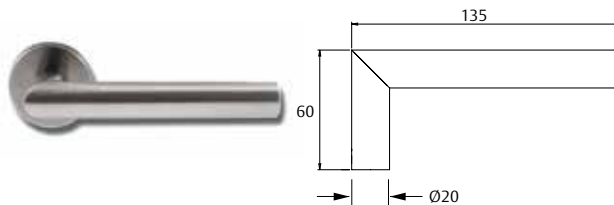

Rosette	Product code	Finish
Rosette	MC5R800	IS16
Long plate	Product code	Finish
Passage	MC5L800	IS16
Cylinder at 47 mm	MC0L847	IS16
Cylinder at 70 mm	MC0L870	IS16
Cylinder at 72 mm	MC0L872	IS16
Cylinder at 85 mm	MC0L885	IS16
Deadbolt at 47 mm	MCEL847	IS16
Deadbolt at 70 mm	MCEL870	IS16
Deadbolt at 72 mm	MCEL872	IS16
Deadbolt at 85 mm	MCEL885	IS16
Square plate	Product code	Finish
Passage	MC5C800	IS16
Cylinder at 47 mm	MC0C847	IS16
Cylinder at 70 mm	MC0C870	IS16
Cylinder at 72 mm	MC0C872	IS16
Cylinder at 85 mm	MC0C885	IS16
Deadbolt at 47 mm	MC3C847	IS16
Deadbolt at 70 mm	MC3C870	IS16
Deadbolt at 72 mm	MC3C872	IS16
Deadbolt at 85 mm	MC3C885	IS16

# Institutional stainless AISI 316L handle

## Planho AISI 316L

### The pack with a rosette includes

- » A set of handles with an internal plate and a cover, a 8x105 mm spindle, 2 recoil springs, 4 coach screws, 2 bolts and an Allen key.

### The pack with a long plate includes

- » A set of handles with an internal plate and a cover, a 8x105 mm spindle, 2 recoil springs, 4 coach screws, 2 bolts and an Allen key.
- » Rectangular plate also available.

### The pack with a squared plate includes

- » A set of handles with a 1'5 mm-thick internal plate and a cover, a 8x105 mm spindle, 2 recoil springs, 5 floating through bolts, 5 screws, 2 bolts and an Allen key.

### Functions

- » Entrance: keyhole at 85, 72, 70 and 47 mm.
- » Privacy: deadbolt at 85, 72, 70 and 47 mm.
- » Passage.

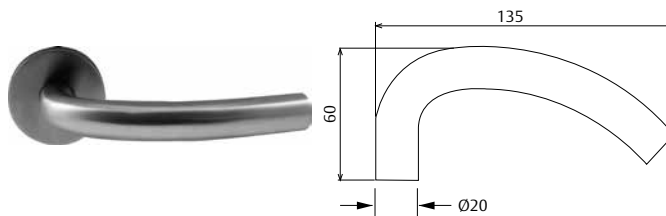

Rosette	Product code	Finish
Rosette	MP5R800	IS16
Long plate	Product code	Finish
Passage	MP5L800	IS16
Cylinder at 47 mm	MP0L847	IS16
Cylinder at 70 mm	MP0L870	IS16
Cylinder at 72 mm	MP0L872	IS16
Cylinder at 85 mm	MP0L885	IS16
Deadbolt at 47 mm	MPEL847	IS16
Deadbolt at 70 mm	MPEL870	IS16
Deadbolt at 72 mm	MPEL872	IS16
Deadbolt at 85 mm	MPEL885	IS16
Square plate	Product code	Finish
Passage	MP5C800	IS16
Cylinder at 47 mm	MP0C847	IS16
Cylinder at 70 mm	MP0C870	IS16
Cylinder at 72 mm	MP0C872	IS16
Cylinder at 85 mm	MP0C885	IS16
Deadbolt at 47 mm	MP3C847	IS16
Deadbolt at 70 mm	MP3C870	IS16
Deadbolt at 72 mm	MP3C872	IS16
Deadbolt at 85 mm	MP3C885	IS16



# Institutional leverset for emergency exits

## Certified product EN179:2008

### Sena Inox AISI 316L

#### Main features

- » Up to 200 kg doors
- » Unlock capacity < 70 N
- » Durability 200.000 cycles
- » E Fire resistance (integrity),
- » I (isolation), B grade
- » This product is certified as a set with CF60 (9 mm spindle) and 2035T, 2037F and 4039T (8 mm spindle).

Certification EN 179:

3 7 6 B 1 3 2 2 A B

Category of use	Durability	Door mass	Suitability	Safety	Resistance	Security	Projection	Type of operation	Field of application
3	7	6	B	1	3	2	2	A	B
High frequency use	Grade 7: 200 000 cycles.	Grade 6: Up to 200kg.	Suitable for use in accordance with EN1634-1.	Safety in use.	Grade 3: 96hr (high resistance)	Grade 2: 1000 N	Projection of device: Grade 2: Projection up to 100 mm	Emergency device with lever handle operation.	B: outward opening slide exit door only

#### The pack with long plate includes:

- » A set of handles with an internal plate and a cover, a split spindle (8 or 9mm), 2 recoil springs, 6 coach screws, 3 bolts and an Allen key.

Product code	
MSCE0L972IS16	C9, for CF60
MSCE0L885IS16	C8, for 2035T, 4039T and 2037F

#### The pack with square plate includes:

- » A set of handles with 1,50 thickness square plates, a split spindle (8 or 9mm), 2 recoil springs, 10 coach screws, 5 bolts and an Allen key.

Product code
MSCE0C972IS16
MSCE0C885IS16

#### The pack with rosette includes:

- » A set of handles with an internal plate and a D50 cover, a split spindle (8 or 9mm), 2 recoil springs, 4 coach screws, 2 bolts and an Allen key.

Product code
MSCE5R900IS16
MSCE5R800IS16



CERTIFIED TO  
UNE-EN  
179:2008

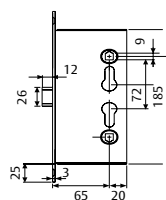

**CF60T.** 9 mm follower  
Reversible

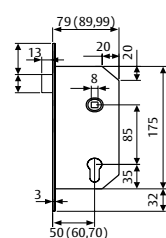

**2035T.** 8 mm follower. Handed.  
No cylinder, for free passing door  
**2037F.** 8 mm follower reversible (non handed). Valid for outside handle locking cylinder  
**4039T.** 8 mm follower. Handed. Cylinder required for external door opening.





# Institutional stainless AISI 316L handle

## Sena pull handle with squared plate

### Functions

- » Entrance: key hole at 85, 72 and 70 mm
- » Privacy: deadbolt at 85, 72 and 70 mm

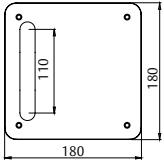
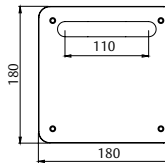
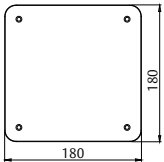
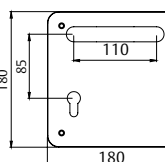
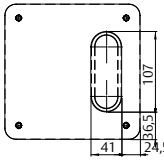
Vertical pull handle	Product code	Finish	Horizontal pull handle	Product code	Finish
	MSMT80V (half)	IS16		MSMT800 (half)	IS16
	MSTT80V (double)	IS16		MSTT800 (double)	IS16
Vertical pull handle	Product code	Finish	Horizontal pull handle	Product code	Finish
	PCCIEGA	IS16		MSTT885	IS16
				MSTT872	IS16
Vertical pull handle	Product code	Finish			
	MSTT80EM	IS16			



# Institutional stainless AISI 316L handle Complements

## Key holes

**The pack includes:**

- » A set with support pieces and covers.
- » 4 coach screws.

**Finish**

- » IS-



Product code	Finish
MBORBOM	IS16

## Thumb turns

**The pack includes:**

- » A set with support pieces and covers.
- » 4 coach screws.

**Finish**

- » LP/LM/CR/CM/MB/NE/NS.



Product code	Finish
MBOREME	IS16

## Blank

**The pack includes:**

- » A set with support pieces and covers.
- » 4 coach screws.

**Finish**

- » IS-16



Product code	Finish
MBOR000	IS16

# Institutional stainless AISI 304 handle

Handles specially designed for offices and institutional buildings with standard applications.

## Stainless steel AISI 304 finish

It is an austenitic steel (18% chromium, 8% nickel). Although austenitic steel is not magnetic, once it's been mechanized it can modify its structure and be attracted by a magnet. It offers excellent corrosion resistance, even in outdoors installations.

## Features

Recoil spring protected by a Delrin cartridge for the rose. Spiral spring system in institutional plate and long plate. Fixing with a through bolts/screw, except in the institutional plate, which is fixed with through bolts.

## Regulations

It meets the requisites of the UNE-EN 1906 standard for building fittings.

It is also above the maximum grade of the corrosion resistance standard UNE-EN 1670.

Ultraviolet resistance: unaffected.

Excellent resistance to chemical attacks.

## Fixing system

Depending on each model, fixing is carried out with fixed through bolts, floating through bolts or coach screws straight onto the door's leaf.



G



# Institutional stainless AISI 304 handle

## Sena AISI 304

### The pack with a rosette includes

- » A set of handles with an internal plate and a cover, a 8x105 mm spindle, 2 recoil springs, 4 coach screws, 2 through bolts, 2 bolts and an Allen key.

### The pack with a long plate includes

- » A set of handles with an internal plate and a cover, a 8x105 mm spindle, 2 recoil springs, 4 coach screws, 2 bolts and an Allen key.

### The pack with a squared plate includes

- » A set of handles with a 1'5 mm-thick internal plate and a cover, a 8x105 mm spindle, 2 recoil springs, 4 floating through bolts, 4 coach screws, 2 through bolts and an Allen key.

### Functions

- » Entrance keyhole at 85, 72, 70 and 47 mm.
- » Privacy: deadbolt at 85, 72, 70 and 47 mm.
- » Passage

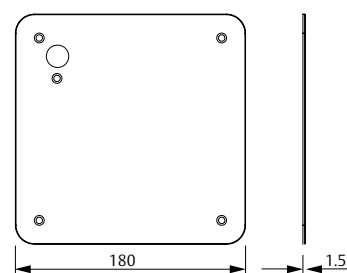
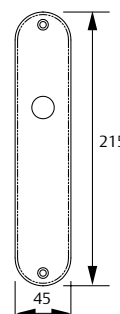
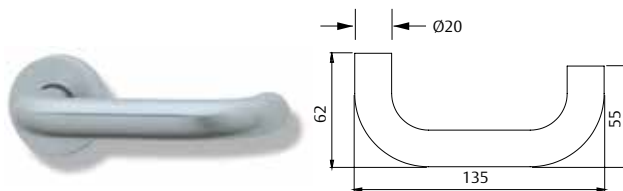

Rosette	Product code	Finish
Rosette	MS5R800	IS-
Long plate	Product code	Finish
Passage	MS5L800	IS-
Cylinder at 47 mm	MS5LR800	IS-
Cylinder at 70 mm	MS0L847	IS-
Cylinder at 72 mm	MS0L870	IS-
Cylinder at 85 mm	MS0L872	IS-
Deadbolt at 47 mm	MS0L885	IS-
Deadbolt at 70 mm	MSEL847	IS-
Deadbolt at 72 mm	MSEL870	IS-
Deadbolt at 85 mm	MSEL872	IS-
Condensa a 85 mm	MSEL885	IS-
Squared plate	Product code	Finish
Passage	MS5C800	IS-
Cylinder at 47 mm	MS0C847	IS-
Cylinder at 70 mm	MS0C870	IS-
Cylinder at 72 mm	MS0C872	IS-
Cylinder at 85 mm	MS0C885	IS-
Deadbolt at 47 mm	MS3C847	IS-
Deadbolt at 70 mm	MS3C870	IS-
Deadbolt at 72 mm	MS3C872	IS-
Deadbolt at 85 mm	MS3C885	IS-

# Institutional stainless AISI 304 handle

## Vector AISI 304

### The pack with a rosette includes

- » A set of handles with an internal plate and a cover, a 8x105 mm spindle, 2 recoil springs, 4 coach screws, 2 through bolts, 2 bolts and an Allen key.

### The pack with a long plate includes

- » A set of handles with an internal plate and a cover, a 8x105 mm spindle, 2 recoil springs, 4 coach screws, 2 bolts and an Allen key.

### The pack with a squared plate includes

- » A set of handles with a 1'5 mm-thick internal plate and a cover, a 8x105 mm spindle, 2 recoil springs, 4 floating through bolts, 4 coach screws, 2 through bolts and an Allen key.

### Functions

- » Entrance keyhole at 85, 72, 70 and 47 mm.
- » Privacy: deadbolt at 85, 72, 70 and 47 mm.
- » Passage

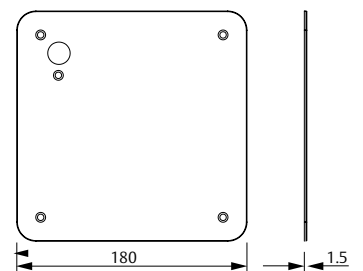
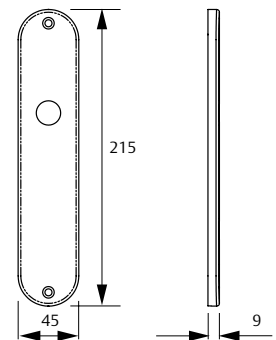
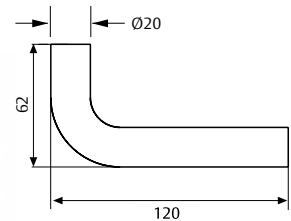

Rosette	Product code	Finish
Rosette	MV5R800	IS-
Long plate	Product code	Finish
Passage	MV5L800	IS-
Cylinder at 47 mm	MV0L847	IS-
Cylinder at 70 mm	MV0L870	IS-
Cylinder at 72 mm	MV0L872	IS-
Cylinder at 85 mm	MV0L885	IS-
Deadbolt at 47 mm	MVEL847	IS-
Deadbolt at 70 mm	MVEL870	IS-
Deadbolt at 72 mm	MVEL872	IS-
Deadbolt at 85 mm	MVEL885	IS-
Squared plate	Product code	Finish
Passage	MV5C800	IS-
Cylinder at 47 mm	MV0C847	IS-
Cylinder at 70 mm	MV0C870	IS-
Cylinder at 72 mm	MV0C872	IS-
Cylinder at 85 mm	MV0C885	IS-
Deadbolt at 47 mm	MV3C847	IS-
Deadbolt at 70 mm	MV3C870	IS-
Deadbolt at 72 mm	MV3C872	IS-
Deadbolt at 85 mm	MV3C885	IS-

# Institutional stainless AISI 304 handle

## Cubo stainless AISI 304

### The pack with a rosette includes

- » A set of handles with an internal plate and a cover, a 8x105 mm spindle, 2 recoil springs, 4 coach screws, 2 through bolts, 2 bolts and an Allen key.

Rosette	Product code	Finish
Rosette	MC5R800	IS-

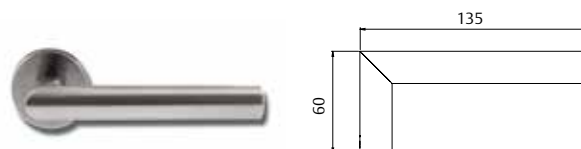

## Ladho stainless AISI 304

### The pack with a rosette includes

- » A set of handles with an internal plate and a cover, a 8x105 mm spindle, 2 recoil springs, 4 coach screws, 2 through bolts, 2 bolts and an Allen key.

Rosette	Product code	Finish
Rosette	ML5R800	IS-

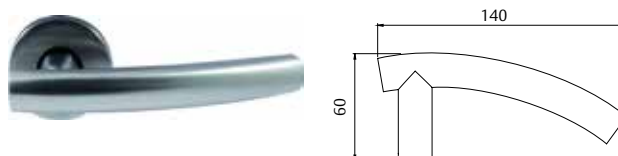

## Radho stainless AISI 304

### The pack with a rosette includes

- » A set of handles with an internal plate and a cover, a 8x105 mm spindle, 2 recoil springs, 4 coach screws, 2 through bolts, 2 bolts and an Allen key.

Rosette	Product code	Finish
Rosette	MR5R800	IS-

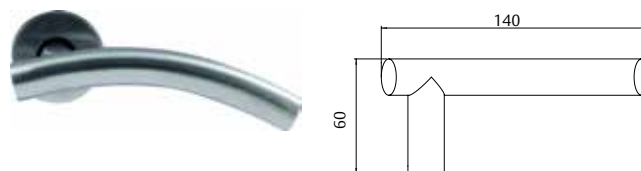

## 9 mm spindle SS304 handle

### The plack with long plate includes:

- » 1 set of handles with steel scutcheon + SS304 covers, 1 9x140 spindle, 2 floating throughblots, 4 screws, 1 allen key.
- » 2 removable recoil springs
- » Up to 70 mm door thickness
- » Double cylinder hole available at 72 mm (MS0L972IS-)
- » Fixed knob on one side (MSTF972IS-)

Long plate	Product code	Finish
Passage	MS5L900	IS-
Cylinder	MS0L972	IS-
1/2 handle + 1 fixed knob	MSTF972	IS-



# Institutional stainless AISI 304 handle complements

## Key holes Ø50

**The pack includes:**

- » A set with support pieces and covers.
- » 4 coach screws.

Finish  
» IS304

Product code	Finish
MB0RBOM	IS-



## Thumb turns Ø50

**The pack includes:**

- » A set with support pieces and covers.
- » 4 coach screws.

Finish  
» IS304

Product code	Finish
MBOREME	IS-



## Blank

**The pack includes:**

- » A set with support pieces and covers.
- » 4 coach screws.

Finish  
» IS304

Product code	Finish
MB0R000	IS-

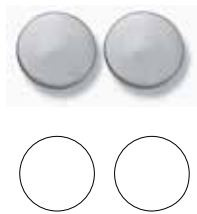

# Solid Lever handles Stainless AISI 304

## Nova Stainless AISI 304

### The pack with a rosette includes

- » A set of handles with an internal plate and a cover, a 8x105mm spindle, 4 coach screws, 2 through bolts, 2 bolts and an Allen key.

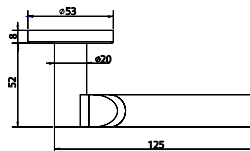

Rosette	Product code	Finish
Rosette	MNV5R800SSIS	IS-

## Oasis Stainless AISI 304

### The pack with a rosette includes

- » A set of handles with an internal plate and a cover, a 8 x105mm spindle, 4 coach screws, 2 through bolts, 2 bolts and an Allen key.

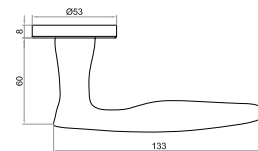

Rosette	Product code	Finish
Rosette	MOA5R800SSIS	IS-

## Wind Stainless AISI 304

### The pack with a rosette includes

- » A set of handles with an internal plate and a cover, a 8x105mm spindle, 4 coach screws, 2 through bolts, 2 bolts and an Allen key.

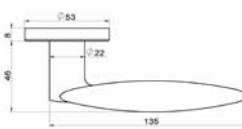

Rosette	Product code	Finish
Rosette	MW15R800SSIS	IS-

## Mach Stainless AISI 304

### The pack with a rosette includes

- » A set of handles with an internal plate and a cover, a 8x105mm spindle, 4 coach screws, 2 through bolts, 2 bolts and an Allen key.

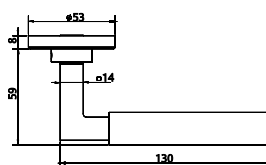

Rosette	Product code	Finish
Rosette	MMH5R800SSIS	IS-



# Solid Lever handles Stainless AISI 304

## Arena Stainless AISI 304

### The pack with a rosette includes

- » A set of handles with an internal plate and a cover, a 8x105mm spindle, 4 coach screws, 2 through bolts, 2 bolts and an Allen key.

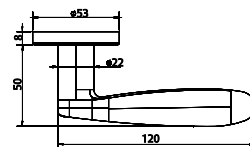

Rosette	Product code	Finish
Rosette	MAR5R800SSIS	IS-

## Funxtion Stainless AISI 304

### The pack with a rosette includes

- » A set of handles with an internal plate and a cover, a 8x105mm spindle, 4 coach screws, 2 through bolts, 2 bolts and an Allen key.

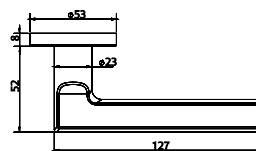

Rosette	Product code	Finish
Rosette	MFU5R800SSIS	IS-

## Marina Stainless AISI 304

### The pack with a rosette includes

- » A set of handles with an internal plate and a cover, a 8x105mm spindle, 4 coach screws, 2 through bolts, 2 bolts and an Allen key.

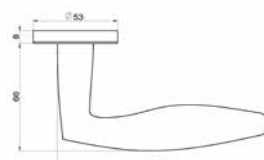

Rosette	Product code	Finish
Rosette	MMA5R800SSIS	IS-

## Yas Stainless AISI 304

### The pack with a rosette includes

- » A set of handles with an internal plate and a cover, a 8x105mm spindle, 4 coach screws, 2 through bolts, 2 bolts and an Allen key.

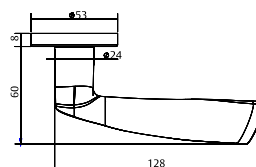

Rosette	Product code	Finish
Rosette	MYA5R800SSIS	IS-



# Institutional stainless AISI 304 handle Complements

## Thumb turns Ø53

**The pack includes:**

- » A set with support pieces and covers. 4 coach screws.

**Finish**

- » IS304

Product code	Finishes
MBOREMESIS	IS
MBOREMESMINIS	IS

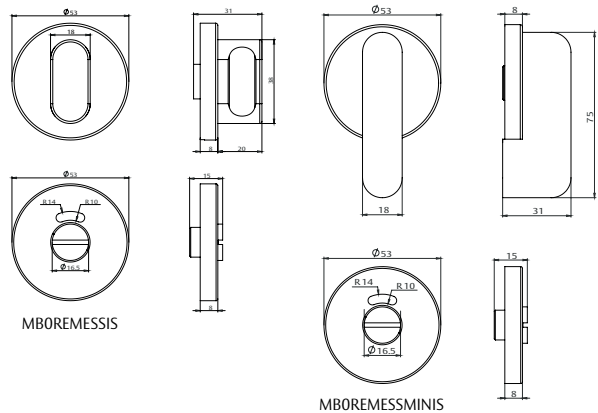

## Door frame deadbolt

- » Deadbolt to install in the door frame, no lock requirement.
- » Deadbolt to install in the sliding door frame, no locks requirement.
- » Limited rotation to 180 degrees.

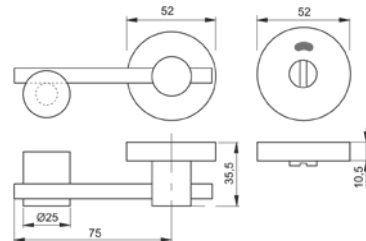

Product code	Features
MARCOEMEIS	Deadbolt without lock
MARCOEMECORIS	Deadbolt for sliding door without lock

## Flush ring Socket pull

**The pack includes:**

- » A set with support pieces and covers.
- » 4 coach screws.

**Finish**

- » IS304

Product code	Finishes
MBOREMEOCIS	IS

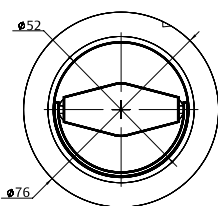

## Flush pull handle - Oval

**The pack includes:**

- » 4 coach screws

**Finish**

- » IS304

Product code	Finishes
TIRUNELOCS	IS



## Cylinder pull - Europrofile

**The pack includes:**

- » 4 wood screws.

**Finish**

- » IS304

Product code	Finishes
TIRADORBOMIS	IS

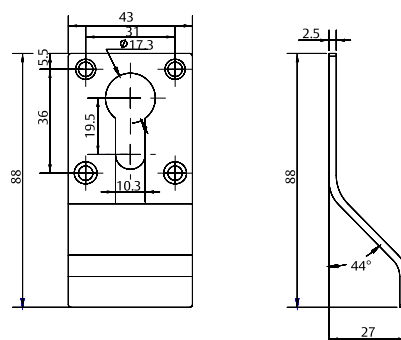

# Accessories - Institutional stainless AISI 304

## Bolts and socket

### Flushbolts - Timber door

The pack includes:  
» Pair, with fixing screws.

Finish  
» IS304

Product code	Finishes	Dimensions
DB3/4SS8IS	IS	3/4 width 8 inches
DB3/4SS10IS	IS	3/4 width 10 inches
DB3/4SS12IS	IS	3/4 width 12 inches

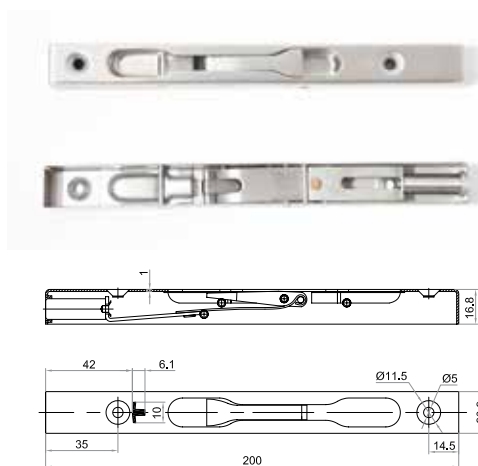

### Flushbolts - Steel door

The pack includes:  
» Pair, with fixing screws.

Finish  
» IS304

Product code	Finishes	Dimensions
DB19SS8IS	IS	19mm - 8 inches
DB19SS10IS	IS	19mm - 10 inches
DB19SS12IS	IS	19mm - 12 inches

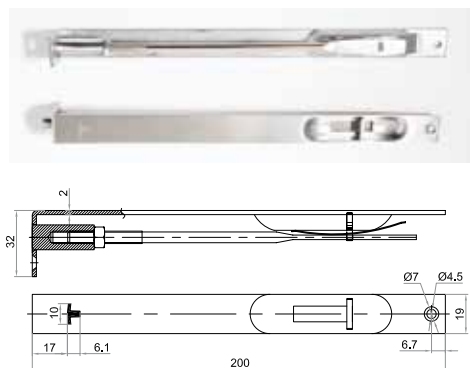

### Extension flushbolts

The pack includes:  
» Pair, with fixing screws.

Finish  
» IS304

Product code	Finishes	Dimensions
DB3/4LSS8IS	IS	3/4 width 8 inches
DB3/4LSS10IS	IS	3/4 width 10 inches

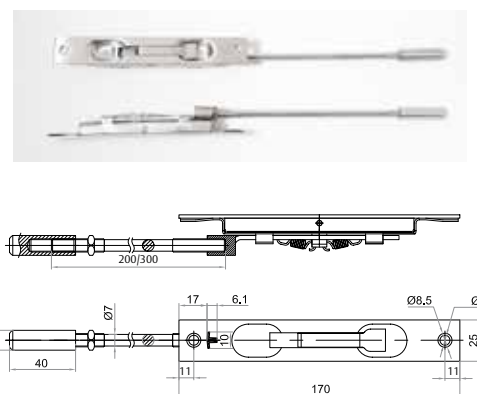

### Dust proof socket

The pack includes:  
» With fixing screws.

Finish  
» IS304

Product code	Finishes	Dimensions
GUARDAPOLIS	IS	D25X38X13.5 (inner hole)

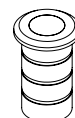
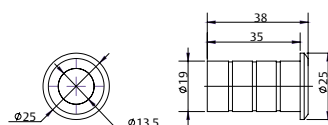



# Accessories

## Institutional stainless AISI 304 plates

### Push plates

The pack includes:  
» fixing screws.

Finish  
» IS304

Product code	Finishes	Dimensions
PCCIEGAIS305100	IS	305x100x1,5 mm
PCCIEGAIS305150	IS	305x100x1,5 mm

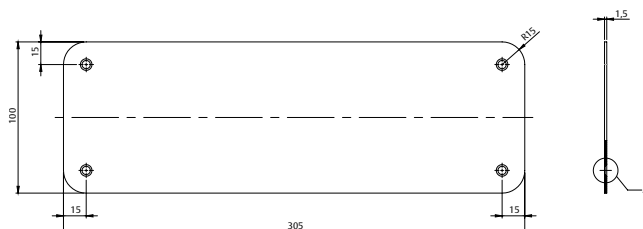

### Kick plates

The pack includes:  
» fixing screws.

Finish  
» IS304

Product code	Finishes	Dimensions
PCCIEGAIS800150	IS	800x150x1,5 mm
PCCIEGAIS100020	IS	1000x200x1,5 mm
PCCIEGAIS100080	IS	1000x800x1,5 mm

### Sign plates

The pack includes:  
» fixing screws.

Finish  
» IS304

Product code	Finishes	Dimensions
VISUALHOMBREIS	IS	1.5mm ENGRAVED; MALE
VISUALMUJERIS	IS	D76x1.5mm ENGRAVED; FEMALE
VISUALMINUSIS	IS	D76x1.5mm ENGRAVED; HANDICAPPED
VISUALUNISEXIS	IS	D76x1.5mm ENGRAVED; UNISEX

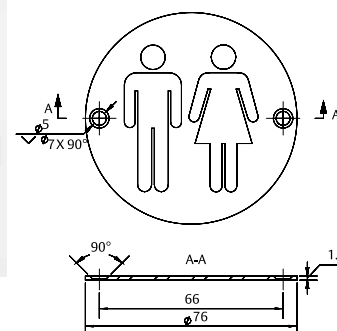

### PULL-PUSH puller

Set of SS304 PULL-PUSH plates, with laser printing.  
D19 x 225 puller fixed by M8 screws. 4 passing throughbolts for both sides.

General dimentions:  
» Plates: 400 x 100 x 1,5 mm.  
» Puller: Ø19 x 225 mm.

Product code	Finishes
TSRPLE100400IS	IS-



# Institutional stainless AISI 304 pull handle

## Solid Type Stainless pull handles

Maximum resistance and durability. Design and ergonomics. These are the most important features for pull handles oriented towards the institutional segment. They will have to endure intensive use, due to the high traffic they are subject to, and meet functionality criteria such as ease of evacuation, etc. They must remain unaffected by any climatic conditions, both indoors and outdoors. But they must also fit in a esthetically with the features of the building, adapting to each project with total precision. TESA brings you a magnificent collection of handles oriented towards the institutional segment, made in stainless steel.

### General features

- » Simple or double installation, M8x70mm fixing screws included.
- » For doors made of wood, glass, metal or PVC.

### Materials and finishes

- » AISI304 Stainless steel.
- » Solid (SS)
- » Hollow (HW)

### Fixations (included)

- » Simple fixation.
- » Double fixation.

### Sizes

- » Check for special sizes and diametres.
- » The length of the pull handle corresponds to the distance between axis
- » Pull handle height = 55mm for Ø19mm and 65mm for Ø10mm.

### Hollow models (HW)



Product code	Model	Description
TR19225HWIS	Simple	Straight unitary pull handle 225x19AISI304
TR19305HWIS	Simple	Straight unitary pull handle 305x19AISI304
DTR19225HWIS	Double	Straight unitary pull handle 225x19AISI304
DTR19305HWIS	Double	Straight unitary pull handle 305x19AISI304

### Solid models (SS)



Product code	Model	Description
TR19225SSIS	Simple	Straight unitary pull handle 225x22AISI304
TR19305SSIS	Simple	Straight unitary pull handle 305x22AISI304
DTR19225SSIS	Double	Straight unitary pull handle 225x22AISI304
DTR19305SSIS	Double	Straight unitary pull handle 305x22AISI304

## Stainless pull handles 20 mm diameter

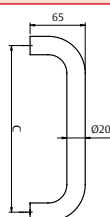

Product code	Model	Description
DTR20150IS	Double	Set of straight pull handles 150X20 IS
DTR20200IS	Double	Set of straight pull handles 200X20 IS
DTR20250IS	Double	Set of straight pull handles 250X20 IS
DTR20300IS	Double	Set of straight pull handles 300X20 IS
TR20150IS	Simple	Straight pull handles 150X20 IS
TR20200IS	Simple	Straight pull handles 200X20 IS
TR20250IS	Simple	Straight pull handles 250X20 IS
TR20300IS	Simple	Straight pull handles 300X20 IS

# Institutional stainless AISI 304 pull handle

## Stainless pull handles 30 mm diameter

Maximum resistance and durability. Design and ergonomics. These are the most important features for pull handles oriented towards the institutional segment. They will have to endure intensive use, due to the high traffic they are subject to, and meet functionality criteria such as ease of evacuation, etc. They must remain unaffected by any climatic conditions, both indoors and outdoors. But they must also fit in aesthetically with the features of the building, adapting to each project with total precision. TESA brings you a magnificent collection of handles oriented towards the institutional segment, made in stainless steel.

### General features

- » Simple or double installation. Fixations included.
- » Available in 20 mm diameter
- » For doors made of wood, glass, metal or PVC.

### Materials and finishes

- » AISI304 Stainless steel.

### Fixations (included)

- » Simple fixation.
- » Double fixation.
- » Fixation in glass, wood and aluminium

### Sizes

- » Each model is available in various sizes between 250mm and 2500mm.
- » Standard sizes.
- » Check for special sizes
- » The length of the pull handle corresponds to the distance between axis
- » Handle height: 90 mm. in all models.

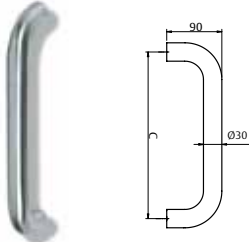
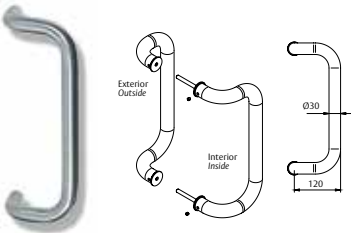
	Product code	Model	Description
	TSR300IS	Simple	Straight unitary pull handle 300X30AIS1304
	TSR350IS	Simple	Straight unitary pull handle 350X30AIS1304
	TSR450IS	Simple	Straight unitary pull handle 450X30AIS1304
	DTSR300IS	Double	Set of straight unitary pull handles 300X30AIS1304
	DTSR350IS	Double	Set of straight unitary pull handles 350X30AIS1304
	DTSR450IS	Double	Set of straight unitary pull handles 450X30AIS1304
	TSC300IS	Simple	Bent unitary pull handle 300X30AIS1304
	TSC350IS	Simple	Bent unitary pull handle 350X30AIS1304
	TSC400IS	Simple	Bent unitary pull handle 400X30AIS1304
	DTSC300IS	Double	Set of bent unitary pull handles 300X30AIS1304
	DTSC350IS	Double	Set of bent unitary pull handles 350X30AIS1304
	DTSC400IS	Double	Set of bent unitary pull handles 400X30AIS1304



# Institutional stainless AISI 304 pull handle

## Stainless pull handles 30 mm diameter

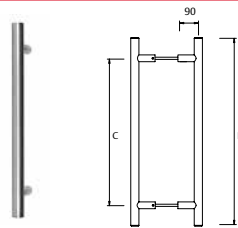

Product code	Model	Description C x L x D
TSRL300IS	Simple	Straight unitary pull handle length 300X600X30IS
TSRL450IS	Simple	Straight unitary pull handle length 450X750X30IS
TSRL600IS	Simple	Straight unitary pull handle length 600X900X30IS
DTSRL300IS	Double	Set of straight unitary pull handles length 300X600X30IS
DTSRL450IS	Double	Set of straight unitary pull handles length 450X750X30IS
DTSRL600IS	Double	Set of straight unitary pull handles length 600X900X30IS

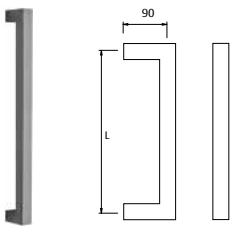

Product code	Model	Description
TSKU300IS	Simple	Kubika unitary pull handle length 300X30IS
TDKU300IS	Double	Set of Kubika pull handles length 300X30IS
TSKU600IS	Simple	Kubika unitary pull handle length 600X30IS
TDKU600IS	Double	Set of Kubika pull handles length 600X30IS

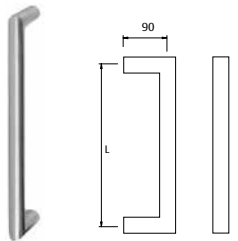

Product code	Model	Description
TSOB300IS	Simple	Obbal unitary pull handle length 300X30IS
TDOB300IS	Double	Set of Obbal pull handles length 300X30IS



# Handles for fire rated doors

## Sena Series

Fire rated and flame-resistant doors preserve the airtightness in a room where a fire has occurred, preventing the flames from spreading to other rooms in the building. The fitting (lock, handle, knob, door closer...) plays an important role here, ensuring the door remains completely closed and no heat or inflammable gases enter the room.

This chapter includes stainless steel handles and steel-based handles.

The Sena series has been certified by the LGAI and the EN 1634-1:2000 standard as a firebreak handle (minimum resistance to fire tests with the corresponding door: 120 minutes).

### Firebreak spindles

In galvanized steel, capable of enduring high temperatures.

### Steel reduction

Valves in 9 to 8 mm, 8 to 7 mm and 8 to 6 mm for firebreak locks.

### Fixing of the handle

Depending on each model, fixing is carried out with fixed through bolts on the internal plate, or floating through bolts / bolts straight onto the door's leaf.



In this case you can order floating through bolts that will go through the door making the installation more resistant. Fixing screws will be hidden in order to prevent the handles from being stolen in public buildings.

### Finishes

- » Stainless steel    AISI 316L
- » Black                Ral 9005

Model	Hand	For lock 2030F	For lock CF50-60	Model	Hand	For lock 2030F	For lock CF50-60
	-	MSOF885NE	MSOF872NE		-		MSMF872NE MSMF872IS16
	-	MS5F800NE	MS5F800NE		-	MSMF800NE MSMF800IS16	
	-	MSOF885IS16	MSOF872IS16		-		MSCF800NE MSCF800IS16
	-				Handle + pull handle	MSTF885NE*	
					Handle + pull handle	MSTF885IS16	
					P. handle + pull handle	MTFEL885IS16	door latch
					P. handle + pull handle	MTFOL885IS16**	
	-	MSMF885NE			Handle + pull handle		MSTF872NE*
		MSMF885IS16					MSTF872IS16
					P. handle + pull handle	TTFOL885IS16	

\* Black ball knob    \*\* Without studs

# Handles for fire rated doors

## Monobloc Series

The MONOBLOC Series has been certified by the DIN 18273 standard for fire rated and flame-resistant doors.

### Handle

Specifically aimed at doors subject to a big strain (hospitals, schools, public buildings).

The internal plate has been fixed to the handle with a black polypropylene coating.

The covers, made of the same material, have been fixed to the internal escutcheon with clips.

Models in which the handle has been attached to the square with a stud bolt (satin black finish) have been certified by the UNE - EN - 1634 - 1: 2000 standard, with a 150 KG. resistance to motion strain and 200,000 actuations.

Specifically designed for locks with DIN sizes (72 mm distance between axis).





### Fixing of the handle

Hidden by knurled floating through bolts that go through the door's leaf from the outside.



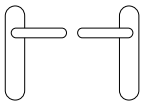
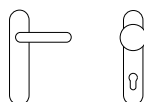
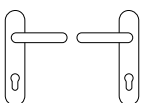

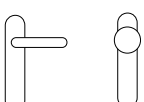

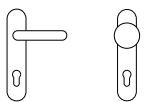



### MONOBLOC Series Finishes

The steel-web handle has a black polypropylene coating has a matt black plypro that gives it rigidity and strength, high resistance to solvents, absence of electrostatic charge and stability against light and temperature variations.

Model	Product code	Finishes	Model	Product code	Finishes
	ME5L900 (Set of passage handles)	NM		METFP72 (Half passage handle and half knobset with keyhole at 72 mm)	NM
	ME0L972 BME0L972 (Includes accessories to tighten the axis of the hinge)	NM		MPTF900 (Half passage knobset)	NM
	METF900 (Half handle and half passage knobset)	NM		MPTF972 (Half knobset with keyhole at 72mm)	NM
	METF972 (Half handle and half knobset with keyhole at 72 mm)	NM			

# Handles for fire rated doors

## Monobloc Series - Parts

Model	Product code	Finishes	Model	Product code	Finishes
	PCM0L000 (Half blank cover)	NM		ECM0L072 (Half escutcheon only with keyhole at 72 mm in zinc plated steel)	NM
	PCM5L900 (Half passage cover)	NM		ECM5L900 (Half passage escutcheon in zinc plated steel)	NMN
	PCM0L072 (Half cover only keyhole at 72 mm)	NM		ACESTMONOBM5 (2 through bolts M5 monobloc range)	NM
	PCM0L972 (Half cover with keyhole at 72mm)	NM		ACCTENSOR BISCF (1000 tensors + CF hinges limit spring)	NM
	ECM0L000 (Half blank escutcheon in zinc plated steel)	NM			

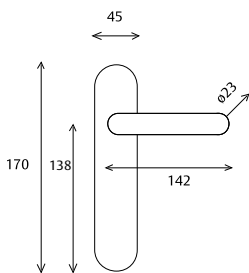

# Handles for Metallic carpentry (steel and aluminium)

## Aluminium series



### Fixing of the handle.

Fixing is carried out with sheet metal screws straight onto the leaf, allowing for the installation of these handles in all kinds of metallic profiles. Distance between axis 43 mm.

### Finishes

 F1 Silver	 F6 Stainless steel
 AN Black	 AB White
 Stainless	 IS

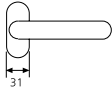
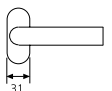

Oval rosette	Product code	Finishes	Oval rosette	Product code	Finishes
	MS50800	F1		MV50800	F1
	MS50800	AN		MV50800	AN
	MS50800	AB		MV50800	AB
	MS50800	F6		MV50800	F6
	MS50800	IS		MV50800	IS
Keyhole	Product code	Finishes	Keyhole	Product code	Finishes
	MOVABOM	F1		MOVABOM	F1
	MOVABOM	AN		MOVABOM	AN
	MOVABOM	AB		MOVABOM	AB
	MOVABOM	F6		MOVABOM	F6
	MOVABOM	IS		MOVABOM	IS

## Aluminium series



### Hidden screws

» The screws that fix the handle to the profile are not visible, preventing the handle from being stolen.

### Fixing of the handle

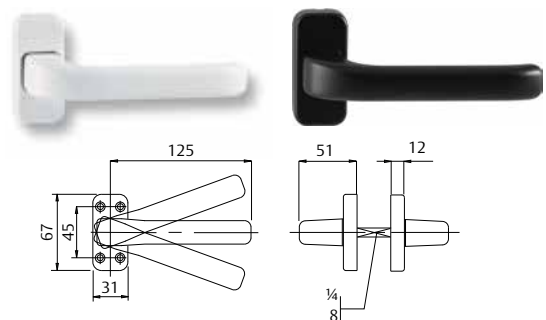
» Fixing is carried out with sheet metal screws straight onto the leaf, allowing for the installation of these handles in all kinds of metallic profiles.

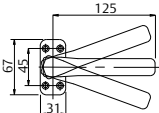

Rosette	Product code	Finishes	Keyhole	Product code	Finishes
	M1500	BL		B3500*	BL
	M1500	NE		B3500*	NE
	M1500V (blister)	BL		B3500	IS
	M1500V (blister)	NE			
	M1500	IS			

Oval rosette	Product code	Finishes
	M2000	BL
	M2000	NE

\* Product code B3500 for handle M1500. Please check for handle M2000

# Solutions for special applications

## Antimicrobial door handle - bio proof product

- » Micro-organisms can be found everywhere and represent a serious problem in the maintenance of infrastructures aimed at public and medical use.
- » It is calculated that 10-20% of nosocomial infections are caused by aerial transmission. Infectious organisms can be dispersed through sneezing, coughing and other means, and many of them fall on a surface in a short space of time.
- » No better solution to this problem has been identified than washing our hands. The habit of washing our hands is not very widespread, occurring in only 40% of the cases in which manual hygiene is recommended.
- » TESA's antimicrobial door handles are stainless steel handles which have a powder coating that makes them resistant to micro-organisms.
- » The active component of this coating is silver ions covered in zeolite, a kind of crystal whose function is to release the silver little by little.
- » Certificates from the University of Pavia are available, they confirm the effectiveness of the coating.
- » Available for any residential handle (except for Solid range) and for any AISI316 handle.
- » Also available for antipanic exit devices and knobset locks.



Product code
MS5C800AM
MS0L885AM
MS5R800AM

## Photoluminescent handle

- » The door handle is suitable for use in evacuation routes, emergency exits and in any room where it is important to be able to locate it immediately without light., for example a garage.
- » It complies with regulation UNE 23035-1 (DIN 67510-1) according to test report N° C/050195. The minimum luminance values required by photoluminescent products which are to be used in signs are:
  - Luminance at 10' >= 40mcd/m2 (n/test: 101.8mcd/m2).
  - Luminance at 60' >= 5.6mcd/m2 (n/test: 13.67mcd/m2).
  - Decay time >= 800' (n/test: 1507').
- » Available for any residential handle (except for Solid range) and for any AISI316 handle.
- » Also available for antipanic exit devices and knobset locks.



Description	Product code
Photoluminescent Sena handle	MS5L800BLFL



# Solutions for special applications

## Stand-alone access control



### Easy and comfortable

CodeHandle is a set of handles with access control without any cards or keys, simple and effective. Its suitable for any kind of interior door, in residential or institutional environments where comfortable and ease of use its a priority. Code handle is the solution for most of the restricted areas: offices, warehouses, private areas, wardrobe, etc.

### Attractive design and easy to install

As the keyboard is integrated in the handle is a more attractive option than the wall readers. Also is very easy to install: without cables, without special drills... you can install it as any other handle.

### Technical features:

- » In doors: patented stand alone access control with code for internal door. A complete set is supplied including handles, rosettes, spindle, fixing through bolts and instructions. For 35 - 80 mm door thickness.
- » In windows, the handle is supplied with fixing screws and instructions.
- » Fits lock cases DIN standard. 8 mm spindle.
- » One master code and up to nine different user codes.
- » Auto locking function available.
- » Two CR2, 3V lithium batteries in the outer handle.
- » Visual and acoustic feedback.
- » Easy to fit, no cables.
- » Available for right- and left hand doors.
- » Only for indoor use.
- » Material: brushed stainless steel and satin chrome zink.

### Normative

CE according to EN 61000-6-1, EN 61000-6-3, EN 61000-4-2, EN 61000-4-3, EN61000-4-8  
Fire certificate EN 1634



### Function:

- » Four buttons to press a four- to six digit code to unlock and one button to lock.
- » Green light flashes and a sound is heard when the buttons are pressed for unlocking.
- » Red light flashes and a sound is heard when locking.
- » Master code and user code is programmed at installation. Can be changed unlimitedly.
- » If wrong code is pressed five times the handle is blocked for three minutes.
- » Free swing from the outside when locked, always possible to open with the handle from the inside.
- » The two batteries gives approximately 2 years.
- » Red light indicates low battery when approximately 500 operations left



Hand definition for Codehandle

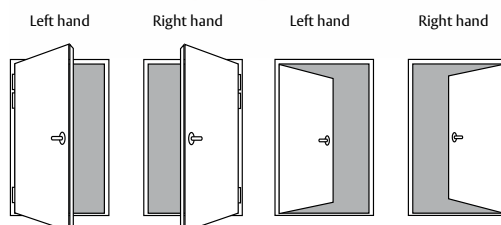

# Solutions for special applications

## Stand-alone access control

### Rosette

Handle for door	Product code	Finish	Hand	Lock
	MCHDR800CM	CM	Right	
	MCHIR800CM	CM	Left	
	MCHSDR800CM	CM	Right / Left	134
				134 PLUS
				2030
				2035
				2UB0F

### Long plate

Handle for door	Product code	Finish	Hand	Lock
	MCHDL800CM	CM	Right	134
	MCHDL872CM	CM	Right	134 PLUS
	MCHDL885CM	CM	Right	2004U
	MCHIL800CM	CM	Left	2030
	MCHIL872CM	CM	Left	2035
	MCHIL885CM	CM	Left	2UB0F
	MCHSDL800CM	CM	Right / Left	2015
				135

### 3500 (retrofit)

**NEW**

Handle for door	Product code	Finish	Hand	Lock	
	MCHD3500CM	CM	Right		
	MCHI3500CM	CM	Left		
					Included 3500 latch

G

# Solutions for special applications

## Electronic digital handle for windows

### Technical features

- » Standard dimensions of spindle windows
- » Includes security screws in one direction
- » 7 mm spindle and 43 mm long
- » Open and close modes
- » Operated by 2 CR2 3V batteries
- » Visual and noise signals
- » Satin Chrome finish
- » Right and left handed

### Application

- » For a quick lock of window or patio doors, without keys. Product patented

### Functions

- » 5 buttons; 4 numbers to insert un-locking code and one more to lock
- » Green light flash and sound signal when opening
- » Red light flash and sound signal when closing or wrong code introduced
- » All delivered handles are programmed with 112233 code installed, easy to change
- » Red light flashing when batteries are about to be changed



**NEW**

Handle for window	Product code	Finish
	MCHV700	CM
	MCHV700	BL



# Solutions for special applications

## For swinging and sliding doors

### DEC: Disabled, Elderly & Children

Specifically designed mechanism for making the access, exit and comfort easier for users with limitations:

- » Handicapped, elderly and children with reduced mobility.
- » Specially for swinging or sliding toilet doors.
- » Geriatric hospitals, health centers, hospitals in general, nursery (school), daycare centers, etc.

### Features:

- » From the outside, when you push the door opens.
- » From the inside, the roller blocks lifting up the handle.
- » From the inside, the roller unblocks lifting down the handle.
- » The rollers allows the opening to the outside and to the inside.
- » In the case of sliding doors instead of a roller we apply a hook. Equivalent system as with the roller.
- » Red sign means occupied and green sign means free.
- » Emergency opening with screwdriver or coin.
- » BRAILLE KIT OPTION: check in the "handles" chapter.
- » ANTIMICROBIAL OPTION: check in the "handles" chapter.

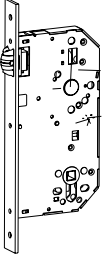

Set DEC solutions	Kind of door	Model	Backset	Finish
	Swinging door	2DEC66DAI	60	AI
	Swinging door	2DEC66IAI	60	AI

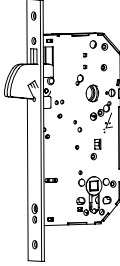
Set DEC solutions	Kind of door	Model	Backset	Finish
	Sliding door	2DEC86DAI	60	AI
	Sliding door	2DEC86IAI	60	AI

DEC solution elements
Swinging lock
Sliding lock
Set of squared plate





# Accessories

## Floating through bolts for doors up to 70 mm (plate and rosette)

	Product code	Features
	TORPLACA	For squared or long plate handles
		Exterior slot - headed
		Interior slot-headed

## Bolts

	Metrics	Product code	Handle	Finishes
	M 6x8A	TORPRI68AIS	Stainless series	Chemical stainless
	M 6x8	TORPRI68IS	Stainless series	Stainless

	Metrics	Product code	Handle	Finishes
	M 5x10	TORPRI510IS	Thema and Hermes series	Stainless
	M 6x9	TORPRI69N	Mare series	Chemical stainless

## Recoil springs

	Product code	Features
	MUELLEL	Thema, Delta and Hermes series Sena and Vector series. Long plate. Unique sense of turn

	Product code	Features
	MUELLELD	Thema, Delta and Hermes series Sena and Vector series Long plate. Double sense of turn

	Product code	Features
	MUELLEC	Serie Mare Roseta

	Product code	Features
	MUELLEM	Mare, squared rosette and long plate series in all the finishes

	Product code	Features
	MUELLERK	Kubica and Obbal series

	Product code	Features
	FUNDA PASOELIS16	Long plate cover Inox 316

## Braille signposting

- » Braille stickers according to UNE 170002.
- » Done in self-adhesive and high relief transparent vinyl.
- » 50 x 30 mm dimensions.





Product code  
KITBRAILLEH







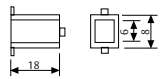
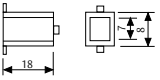

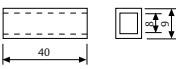

Product code  
KITBRAILLEM

# Accessories

## Reducers

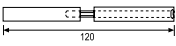
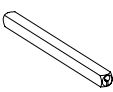
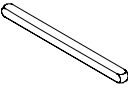
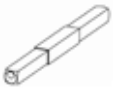
Models	Product code	Features
	44600HH	From 8 to 6 mm For fire rated locks with single nut
	44700HH	From 8 to 7 mm For fire rated locks with single nut
	44900HH	From 9 to 8 mm For fire rated locks with double nut
	CASQUCF50	From 9 to 8 mm For fire rated locks with single nut

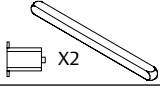
## Spindles

Models	Product code	Features
	MEDCUADRA	Half spindle 8x8x60 mm.
	CUADRAM CUADRAM80	Half spindle with seesaw, 8x8x65 mm Half spindle with seesaw, 8x8x80 mm
	CUADRAB80	Half expansion spindle, 8x8x80 mm
	CUADRA8M	Expansion spindle 8x8x105 mm (for doors between 30 and 55mm)
	CDFUEGO8M	Fire double nut spindle 8x120 mm
	CUADRA8140M	8X140 mm MARE spindle (for doors between 55 and 90mm)
	CUADRA8150	Spindle 8X150 mm (for doors between 90 and 100mm)
	CUADRA898120	Spindle 8x40 - 9x40 - 8x40
	CUADRAE	Fixed spindle that prevents the turn of the handle
	KITCUADRA87	Kit for setting up 8 mm spindle handles with 7 mm spindle locks
	CLIPSEGD16	Additional security clip





---

## **ASSA ABLOY**

Talleres de Escoriaza, S.A.U.  
Barrio Ventas, 35 • E-20305 Irun • SPAIN  
Tel.: +34 943 669 100 • Fax: +34 943 633 221  
[www.tesa.es](http://www.tesa.es)

ASSA ABLOY is the global leader in door opening solutions,  
dedicated to satisfying end-user needs for security, safety and convenience.